

(Sept 1970)

This manual obsoletes and incorporates portions of E20-8158.

Requests for copies of IBM publications should be made to your IBM representative or to the IBM branch office serving your locality. Address comments concerning the contents of this publication to IBM Corporation, DPD Education Development - Publications Services, Education Center, South Road, Poughkeepsie, New York 12602.

© Copyright International Business Machines Corporation 1970

FOREWORD

- AUDIENCE** - This manual is intended for the user of data processing equipment who has a need for data communication services.
- PURPOSE** - It introduces the reader to the world of data communication and enables him to approach common carriers for competent, detailed up-to-date information on facilities, specifications and tariffs to satisfy his needs.
- SCOPE** - The reader should gain sufficient comprehension of first principles in coding structures, modes of transmission, channels and services offered to the public by common carriers to assist him in the design of application-oriented data communication systems.
- An example manual network design problem is included. A bibliography provides further sources for specific areas of interest.
- DISCLAIMER** - Cost figures in this manual were estimated by IBM for purposes of illustration only. They reflect prices obtained from public tariff information and assumptions made by IBM as to the application of the tariffs. The reader should consult the appropriate common carrier for exact tariffs and services when doing actual systems design.
- ACKNOWLEDGEMENT** - The number of individuals and groups who have contributed to this manual makes it impractical to give individual credit. Their contributions are greatly appreciated for they have helped to make this a more useful publication.

CONTENTS

Introduction	1	Private Line Services	24
Communications Concepts	1	Teletypewriter Grade (dc)	24
Channels	1	Subvoice	26
Number Systems	2	Voice Grade Services	26
Communications Coding Structure	3	Public Exchange	26
Baudot Code	3	Telephone System	26
Data Interchange Code	4	Wide Area Telephone Services	
The Data Interchange Code (DIC)	4	(WATS)	30
ASCII Code	4	Broadband Exchange Services	
Four-of-Eight Code	4	(BEX)	30
Hollerith Code	5	Private Line	31
Binary Coded Decimal Code	5	Voice Grade Channel	31
Modes of Transmission	6	Conditioned Voice Grade Channels ...	31
Line Speeds	7	Broadband Services	31
Circuit Concepts	8	Public Exchange	31
Signal Representation	8	Private Line	31
Modulation	9	Groups of Channels	32
Amplitude Modulation	9	Communication Systems	36
Frequency Modulation	9	Switching Concepts	36
Phase Modulation	9	Telephone Switching or Circuit Switching ..	36
Pulse Modulation	10	Message Switching	38
Multiplexing Techniques	10	Teletypewriter Switching Methods	38
Frequency Division Multiplexing	10	Manual Torn-Tape Switching	38
Time Multiplexing	11	Semi-Automatic Switching	38
Circuit Limitations	11	Automatic Switching	39
Frequency Distortion	11	General Message Switching	39
Delay Distortion	11	Selective Calling and Polling	39
Noise Signals	13	Line Control	39
White Noise	13	Line Control Systems	40
Impulse Noise	13	AT&T 81D1	40
Effects of Errors on Performance	13	General Method of Operation	41
Error Detection	14	Outgoing Multistation Lines	41
Error Correction	15	Outgoing Single Station Lines	41
Communications Channels	15	Outgoing Single Trunk	41
Telegraph Grade Channels	17	Outgoing Multichannel Trunks	42
Sub-Voice Grade Channels	17	Sending from Multistation Lines	42
Voice Grade Channels	17	Multiple Address	42
Line Amplifiers	17	Group Code	43
Two-Wire Circuits	17	Intercept	43
Four-Wire Circuits	17	Other Line Control Systems	43
Conditioned Voice Grade Lines	18	AT&T 83B Type Equipment	43
Broadband Channels	18	Western Union Plan 115	43
Special Channel Facilities	19	Computer Message Control Concepts	44
Communication Service Offerings	20	The Message Control Center	44
Low Speed Service	22	Message Identification	45
Teletypewriter Exchange Service	22	Message Routing	45
TWX CE (TWX - Prime)	22	Message Queuing	46
Telex	23	Terminal and Line Control	46
High Speed Offerings Operating		Speed and Code Conversion	46
at Low Speed	24	Message Intercept	47
		Willful Intercept	47
		Editing	47

Priority Handling	47	Manual Design - Leased Network-	
Long Term Message Filing	47	Utilization Criteria	59
Message Retrieval	47	Leased Line -Response Time	
Data Protection	48	Criteria	59
Error Control	48	Switched Network	62
		Manual Design- Summary	63
Common Carriers	48	Line Cost Analysis	63
The Federal Communications		Definitions	63
Commission	49	Pricing a Network	64
State Utility Commissions	49	Design Evaluation	64
International Telecommunications Union ...	49		
The Bell System	49	Appendix A1 - Telephone Techniques	64
Wats	49	Basic Principles	64
Telpak	50	Telephone Receiver Construction	65
Teletypewriter Exchange Service	50	Telephone Transmitter Construction ...	65
DATA-PHONE Service	50	Basic Circuits	65
Other Services	50		
General Telephone and Electronics		Appendix A2 - Telegraph Techniques	66
Corporation	50	Basic Principles	66
Independent Telephone Companies	50	Basic Device Operation	66
Western Union	51	Telegraph Repeaters	68
ITT World Communications, Inc.	51	Telegraph Distortion	69
RCA Communications, Inc.	51	Bias Distortion	69
Privately Owned Communications		Characteristic Distortion	69
Systems	52	Fortuitous Distortion	69
Network Design	52		
Introduction	52	Appendix A3 - Coaxial Cable and Microwave ..	69
Data Analysis	52	Coaxial Cable	69
Remote Station Description	52	Microwave Systems	70
Operational Description	52		
Traffic Analysis	53	Appendix A4 - Data Set Operation	71
Design Criteria	57		
Channel Loading	58	Appendix B - Example of Manual Network	
Terminal Locations	58	Design	73
Central Switching Locations	58		
Present System Description	58	Appendix C - Telecommunications	
Operating Periods	58	Bibliography	76
Operating Constraints	58		
Terminal Selection	58		

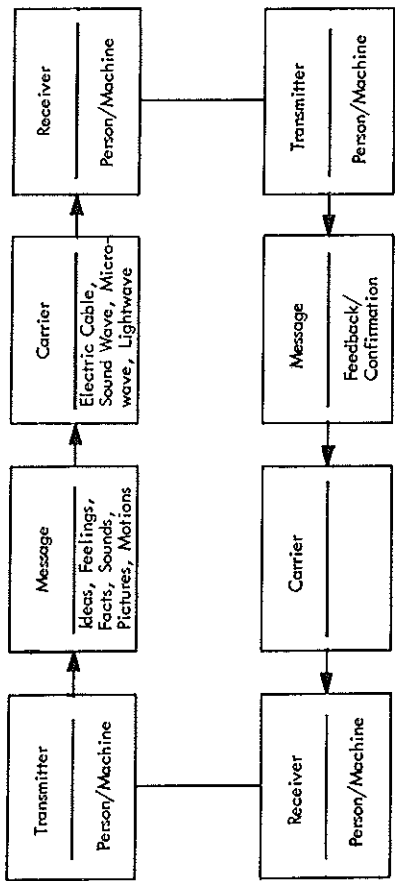

Figure 1A - The Communications Process

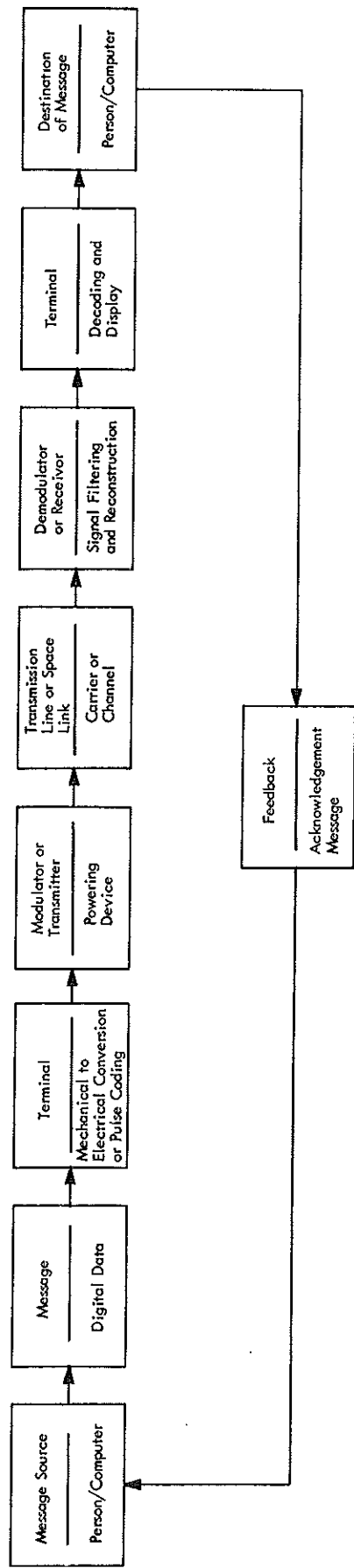

Figure 1B - Conceptual Telecommunications Network

INTRODUCTION

Managements of today's complex and diversified businesses must have up to date knowledge of their geographically scattered operations in order to serve their customers, and to maintain close surveillance over critical activities. This calls for rapid collection, processing, and subsequent use of business information.

Because data collection by messenger or mail is slow and subject to weather and traffic conditions, many new types of communications systems have been developed. Advances in computer design and application, have brought about increased use of electronic transmission systems for conveying information between widely separated business locations and the computers installed there. Thus, it is possible for the management at the main office to know in seconds what the state of affairs is at a branch at the other end of the country.

COMMUNICATIONS CONCEPTS

In this publication communication is defined as the transmission of signals between points of origin and destination without alteration of the sequence or of the information content of such transmission. A special form of communication whereby information is conveyed over a distance is called telecommunications. Telephone, radio, and television are examples of modern telecommunications.

The communication process generally requires at least four parts — a transmitter or source of information; a message; a transmission channel or carrier, often called a data link; and a receiver of transmitted information. Feedback is usually required to close the loop. This is illustrated in Figure 1.

CHANNELS

A channel or communications link is defined as a path for electrical transmission between two or more stations or terminals. It may be a single wire, a group of wires or a special part of the radio frequency spectrum. The purpose of a channel is to carry information from one location to another. All channels have limitations on their information handling abilities, depending upon their electrical and physical characteristics. The term "circuit" is used conversationally as a synonym for channel, but in practice, a circuit may contain several communications channels.

Three basic types of channels are simplex, half-duplex and full duplex. As an example of each, consider transmission between points A and B in Figure 2.

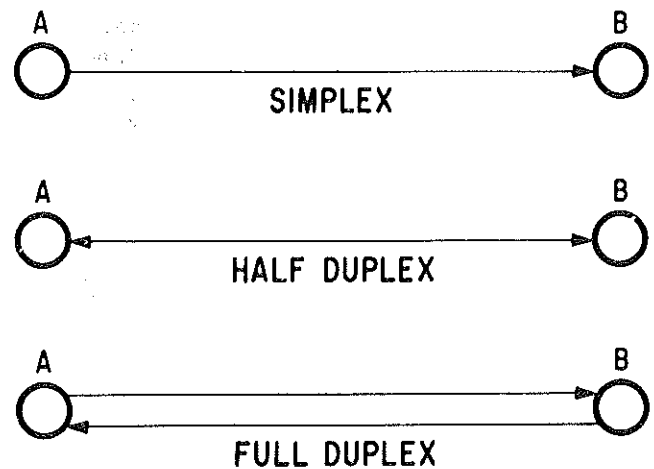

Figure 2. Types of channels

Transmission from A to B only and not from B to A, describes a simplex channel.

Transmission from A to B and then from B to A but not simultaneously, describes a half-duplex channel.

Transmission from A to B and from B to A simultaneously describes a full-duplex transmission.

Usually, all three types of channels are available. In the United States the communications companies or common carriers offer only half or full duplex channels. The half duplex channel may be used in simplex mode by the selection of terminals which restrict the direction of the half-duplex channel, e.g., A "transmit only" terminal connected to a "receive only" terminal. Figure 2 illustrates the channel terminology.

Data can be transmitted in half or full duplex modes over two or four wire facilities. The assumption that half-duplex operation utilizes a 2-wire circuit and a full duplex requires a 4 wire circuit can be erroneous. In most instances half-duplex transmission is over a 2-wire circuit; however, full duplex transmission can be handled by a 2-wire circuit. The 2- or 4-wire selection is the common carrier's responsibility, unless terminal specifications call for 2-wire or 4-wire connections.

In addition to the direction of transmission a channel is characterized by its band width. In general the greater the band width of the assigned channel the higher the possible speed of transmission. This speed is usually measured in terms of bits/sec. The bits are formed into data characters or control codes by equipment included in the terminals.

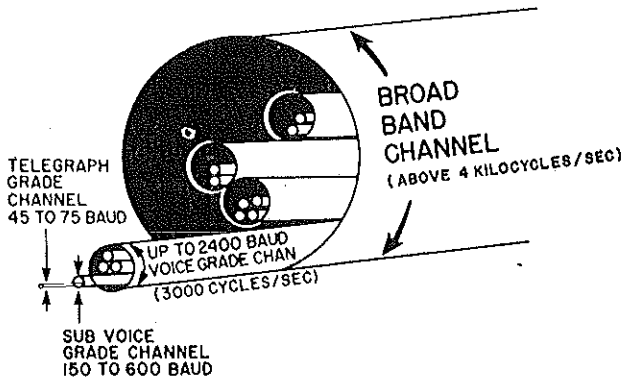

Figure 3. Transmission facilities

Data channels are graded or identified on the basis of their information carrying capacity as specified by their bit speed capability. The range of channels includes broad band, voice grade, sub voice grade and telegraph. Broad band, as its name implies, is the widest or highest grade, while telegraph is the narrowest or lowest grade channel as illustrated in Figure 3.

NUMBER SYSTEMS

People are used to calculating with decimal numbers. However, the decimal number system does not lend itself directly to stored program computer handling or data transmission. Numbers in the computer are best represented by an on-off condition for reasons of efficiency, economy and speed. Therefore, the binary number system is used.

Let us review what we already know of the decimal number system and then go on to the binary system.

In the decimal system we use the ten symbols 0, 1, 2, 3, 4, 9. When we record the decimal number one hundred seventy six we use the shorthand positional notation 176. However, we really mean the sum of:

$$\begin{array}{ccc} \text{(hundreds)} & \text{(tens)} & \text{(units)} \\ (1 \times 100) & + (7 \times 10) & + (6 \times 1) = 176 \end{array}$$

or

$$(1 \times 10^2) + (7 \times 10^1) + (6 \times 10^0) = 176$$

In the binary number system we are limited to the two symbols 1 and 0. As a result the binary number 101 is the shorthand positional notation for the sum of:

$$\dots (16) (8) (4) (2) (1) \\ (1 \times 4) + (0 \times 2) + (1 \times 1) = 5 \text{ (decimal)}$$

or

$$(1 \times 2) + (0 \times 2) + (1 \times 2) = 5 \text{ (decimal)}$$

Note that in the decimal number system we are using powers of 10 to differentiate the positional values whereas in binary we are using powers of 2.

These two number systems are analogous to two languages; and we must translate between them. Let's try several examples using the above technique of positional notation.

Example 1. Translate the decimal number 6 to binary

$$6 = (_ \times 2^2) + (_ \times 2^1) + (_ \times 2^0)$$

$$6 = \underline{1} \times 4 + \underline{1} \times 2 + \underline{0} \times 1$$

Here we fill in the blanks to equal the 6 on the left. Obviously one (1) four plus one (1) two equal 6.

$$6_{10} = 110_2$$

We use the subscripts to show which is the decimal and which is the binary number.

Example II. Translate the decimal number 21 to binary.

$$21_{10} = (_ \times 2^2) + (_ \times 2^1) + (_ \times 2^0)$$

Here we run into an apparent difficulty because all of the numbers on the right hand side of the equation cannot equal the left hand side (21). Therefore we must add three more powers of 2.

$$21_{10} = (_ \times 2^5) + (_ \times 2^4) + (_ \times 2^3) + (_ \times 2^2) \\ + (_ \times 2^1) + (_ \times 2^0)$$

Since $2^5 = 32$ ($2 \times 2 \times 2 \times 2 \times 2$) we cannot place a one (1) in that position: Therefore, the binary value of $21_{10} = 010101_2$ or

$$21_{10} = (0 \times 2^5) + (1 \times 2^4) + (0 \times 2^3) + (1 \times 2^2) + (0 \times 2^1) + (1 \times 2^0)$$

$$21_{10} = 0 + 16 + 0 + 4 + 0 + 1$$

$$21_{10} = 0 \quad 1 \quad 0 \quad 1 \quad 0 \quad 1$$

$$21_{10} = 010101_2$$

Now prove the following translation:

$$28_{10} = (?)_2$$

$$\text{answer: } 28_{10} = 11100_2$$

The above discussion interpreted the binary positional value as a number we are used to in the decimal system. However, we could just as easily use this system to represent alphabetic characters. For example, using six binary digits (referred to as bits) let us build a coding scheme to represent an alphabetic sequence:

A=	110001 ₂	G=	110111 ₂
B=	110010 ₂	H=	111000 ₂
C=	110011 ₂	I=	111001 ₂
D=	110100 ₂	J=	100001 ₂
E=	110101 ₂	K=	100010 ₂
F=	110110 ₂	L=	100011 ₂

Etc.

Notice that each alphabetic character has a unique representation in binary. Here we see what binary representation really is. First it is a tool for representing data, whether it be numbers in positional notation or alphabetic characters in a notation we arbitrarily assign. Secondly, it performs the above service in the most economical manner. The previous example is a special notation called binary-coded decimal or BCD.

COMMUNICATIONS CODING STRUCTURES.

In communications and data processing, information can be transmitted in sequence bit by bit over an information channel. This method may be referred to as a timed bit train. For example the five bits 10110 could be represented as follows:

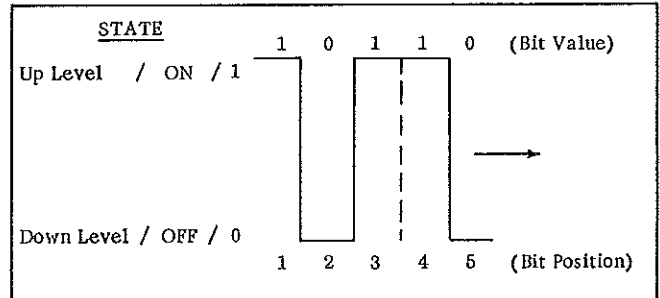
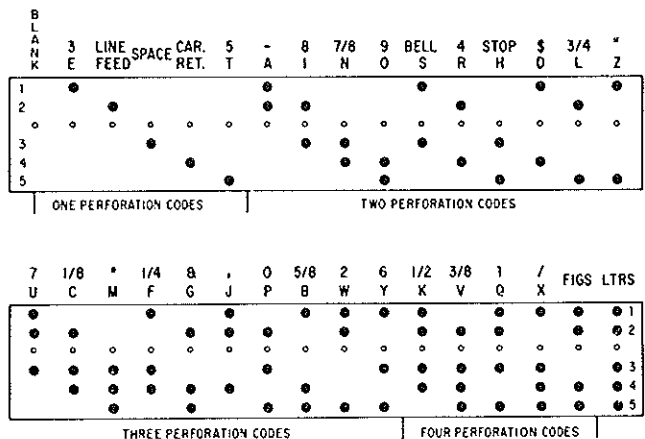

Figure 4. Bit train

Baudot Code

The Baudot code uses five bits to represent each character as shown in Figure 5. However, this coding structure will allow only 2^5 or 32 combinations. A code with only 32 characters would not permit identification of the 26 alphabetic letters and 10 digits of the decimal system. To overcome this problem, the Baudot code assigns two characters to many of the five bit combinations.

To distinguish between two characters having the same code and thereby increase effectiveness of the entire code to 57 characters and functions, two shift characters are utilized. A "letters" character is used to signify lower case printing, a "figures"



NOTE: THE UPPER CASE ASSIGNMENTS SHOWN REPRESENT ONE OF MANY SETS IN COMMON USAGE. ONLY THE DIGITS ARE STANDARD AMONG THEM.

Figure 5. Baudot code

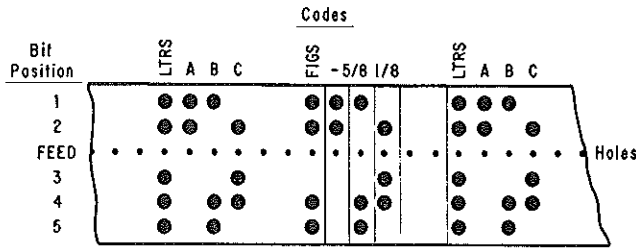

Figure 6. Effect of "figs-ltrs" codes

character is used to signify upper case printing. Figure 6 demonstrates the effect of "figs" - "ltrs" conditioning on the same three code combinations.

In "ltrs" shift, the machine will print A, B, and C while in "figs" shift, -, 5/8, and 1/8 are printed from the same three codes. The necessity to insert "figs" - "ltrs" shift codes when going from alphabets to numerics with devices using Baudot Code can be significant because more characters must be transmitted for a given application than would be needed for a non-shifted code set.

Data Interchange Code

Another type of coding structure is the American Standard Code for Information Interchange. A version of this code shown in Figure 7 is used in machines manufactured by Teletype Corporation, which has named this version of ASCII the Data Interchange Code. It is an eight-bit code, sometimes referred to as an eight-level code, with the eighth level used for even parity checking.

Does not permit printing dual case (small and capital) letters but does have shift capability. Rather than having separate upper and lower case shift codes, each character by its code structure identifies whether the machine should be in upper or lower case. The DIC keyboard has provision for a third case or a control shift which permits certain of the typing keys to initiate control characters for functions such as tabulation and form positioning.

ASCII Code

ASCII is an eight-bit code developed as an American Standard. The information is represented by 7 information bits and one parity bit. The code as presently specified is illustrated in Figure 8 and contains 128 characters; 94 graphic characters and 34 control symbols. In both ASCII and DIC the complete alphabet is represented in a continuous binary sequency.

Four-of-Eight Code

Another code commonly used for data transmission is the Four-of-Eight code. It is a special fixed-count code always having four one bits and four zero bits out of the possible eight that are transmitted for each character. The fact that every character is always identified by four "one bits" (never more nor less) facilitates accuracy checking of transmitted data.

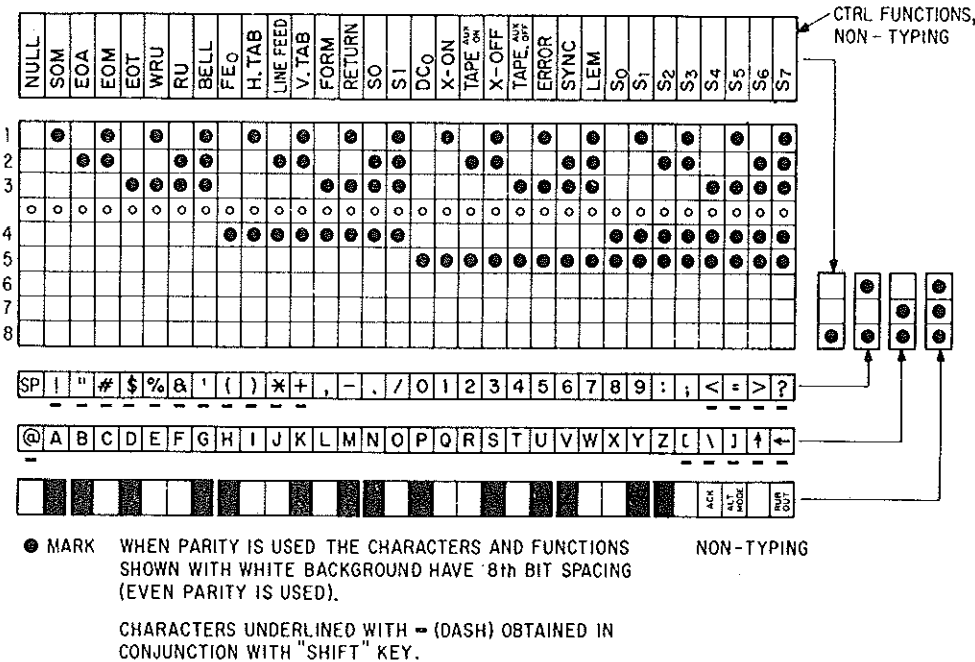

Figure 7. Data interchange code

Bit Positions b ₄ b ₃ b ₂ b ₁				0 0	0 0	0 1	0 1	1 0	1 0	1 1	1 1
0 0 0 0				0	1	2	3	4	5	6	7
0	0	0	0	NUL	DLE	SP	0		P	@	p
0	0	0	1	SOH	DC1	!	1	A	Q	o	q
0	0	1	0	2	DC2	"	2	B	R	b	r
0	0	1	1	3	DC3	#	3	C	S	c	s
0	1	0	0	4	DC4	\$	4	D	T	d	t
0	1	0	1	5	NAK	%	5	E	U	e	u
0	1	1	0	6	ACK	^	6	F	V	f	v
0	1	1	1	7	BEL	^	7	G	W	g	w
1	0	0	0	8	BS	(8	H	X	h	x
1	0	0	1	9	HT)	9	I	Y	i	y
1	0	1	0	10	LF	*	:	J	Z	j	z
1	0	1	1	11	VT	+	;	K	[k	{
1	1	0	0	12	FF	<	<	L	~	l	~
1	1	0	1	13	CR	=	=	M]	m	}
1	1	1	0	14	SO	.	>	N	^	n	!
1	1	1	1	15	SI	/	?	O	_	o	DEL

Figure 8. ASCII code

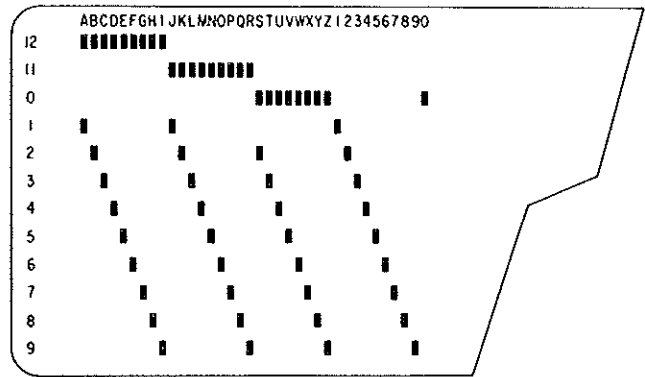

Figure 9. Hollerith (IBM punched card) code

Hollerith Code

Hollerith Code is based on the decimal notation system. The character set is segmented by zones so that the combination of the 12, 11 or zero zone and the digits 1 through 9 completes the alphabet. The zero zone alone represents zero and the digit 1 thru 9 without a zone represents the numbers. Other combinations of punches are used to represent special characters. Notice in Figure 9 that each character is determined by a unique coding structure.

Binary Coded Decimal

The binary coded decimal is an extension of the Hollerith Code. The code is structured by converting the punched card designations to a binary pattern. The 12, 11, and zero zones become a two-bit combination and the digits a four-bit pattern.

When this code (BCD) is extended to include eight bits it becomes the EBCDIC code shown in Figure 10.

The importance of coding is not the ability to recognize characters by their code but rather an

Bit Positions 23 00				01				10				11								
4567				00	01	10	11	00	01	10	11	00	01	10	11	00	01	10	11	
0000	NUL			Blank	&	-										>	<	†	0	
0001						/		a	i							A	J		1	
0010								b	k	s						B	K	S	2	
0011								c	l	t						C	L	T	3	
0100	PF	RES	BYP	PN					d	m	u						D	M	U	4
0101	HT	NL	LF	RS					e	n	v						E	N	V	5
0110	LC	BS	EOB	UC					f	o	w						F	O	W	6
0111	DEL	IDL	PRE	EOT					g	p	x						G	P	X	7
1000									h	q	y						H	Q	Y	8
1001					.		/	"	i	r	z						I	R	Z	9
1010					?	!		:												
1011					.	S	,	#												
1100					←	*	%	@												
1101					()	^	~												
1110					+	;	-	=												
1111					£	∅	±	/												

Figure 10. Extended Binary-Coded-Decimal Interchange Code (EBCDIC)

evaluation of the following: (1) How much information a code contains; (2) Its limitations in number of print characters and functions; (3) What grade communications channel may be required to transmit this code at a given character rate (characters per second).

We have now introduced several techniques for coding information. These can be used to represent numerical values through positional notation or alphabetic information by assigning unique bit configurations to characters. We can then transmit this information via communication channels at various speeds. Which one of the many methods we use depends upon the cost, thrupt requirements, and checking needs of the application.

MODES OF TRANSMISSION

There are two primary modes of transmission. They are asynchronous and synchronous.

A typical asynchronous signal (used in Baudot Teletypewriter machines) is shown in Figure 11.

The five information bits representing a character are preceded by a zero bit one unit of time in length and followed by a one bit of 1.42 units of time. These "start" and "stop" bits are used to separate characters and to synchronize the receiving station with the transmitting station. When signal elements or bits of a character travel in a transmission medium in sequence (first bit first, etc.) as shown in Figure 12, it is called a serial mode or serial transmission. With the start and

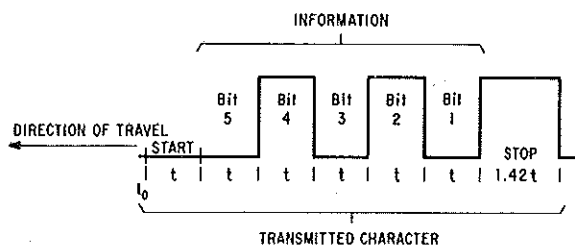

Figure 11. Asynchronous signal

stop bits added, this type transmission is called serial start-stop or asynchronous, meaning each character is individually synchronized.

Figure 12 shows a series of bits travelling in a communications medium without the start-stop bits. This is synchronous transmission. It requires more complex and, usually, more costly terminal equipment. A synchronous system is a "clocked" or "fixed rate" system, meaning the line is sampled at regular intervals to receive and record information bits. Synchronous transmission permits more information to be passed over a circuit per unit time because no transmission time is required for the insertion of start-stop signal elements. This is illustrated in Figures 12A & 12B which show 21 units of time are required for asynchronous transmission compared to only 15 units for synchronous transmission of the same information.

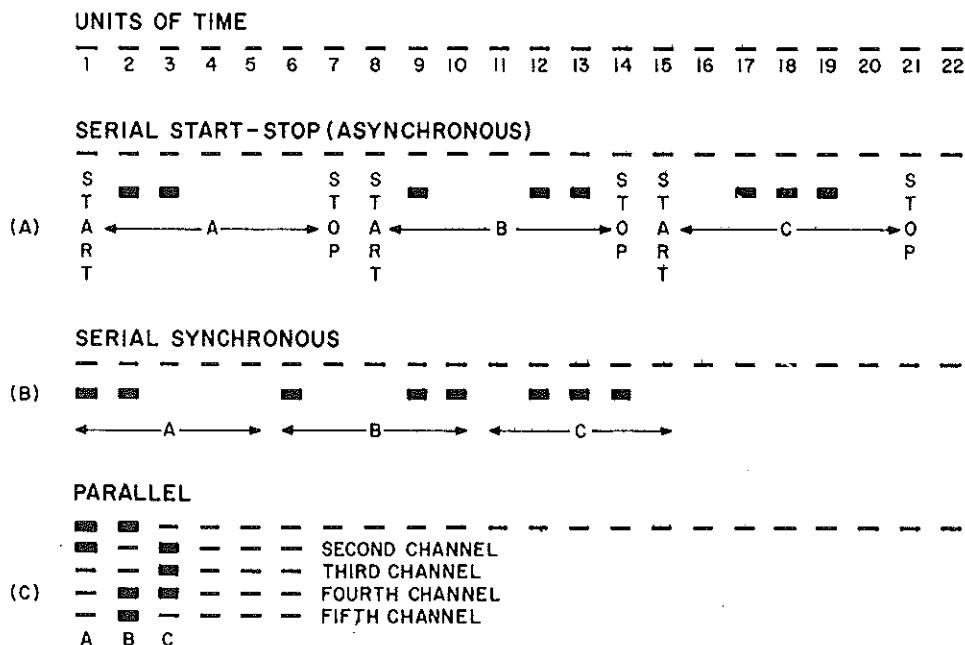

Figure 12. Transmission modes

TABLE 1

	Serial		
	Start - Stop	Synchronous	Parallel
Advantages	Little, if any, data lost through lack of synchronization as each character is individually synchronized.	Good ratio of data to control bits (low redundancy)	Low cost transmitter
Disadvantages	High rate of control information to data information (high redundancy)	Much data can be lost between synch pattern if devices become "un-synched"	High cost receiver may waste bandwidth

It is possible to send all the information bits in a character simultaneously over separate paths or channels as shown in Figure 12C. This mode of communication is called parallel transmission.

The advantage of parallel transmission, that makes the transmitters less costly than the receiving equipment, is the relatively low cost of producing such a signal. The parallel mode of transmission is most commonly used where the increased bandwidth is cheaper than serializing equipment, or where more transmitters are required than receivers.

Let us summarize the advantages and disadvantages of the various methods of transmission discussed so far (see Table 1).

LINE SPEEDS

Regardless of the mode of transmission (serial or parallel), the measure of the maximum speed at which information can be conveyed is called the Bit Rate. In high speed data communications, the term kilobits, meaning thousands of bits per second, is often used.

The line signalling speed is measured in bauds. The baud is defined as the reciprocal of the length in seconds of the shortest element in the signaling code. A bit is defined as a single binary decision. A bit per second is equal to a baud. Figure 13 shows how signal amplitude may be used as a coding method.

Line speeds also can be expressed in either words per minute or characters per second. Characters per second is most commonly used to express the operating speed of a parallel transmission system. However, direct equivalency exists between bit rate, words per minute and characters per second. If any measure of speed is known, the other two expressions can be calculated.

In communications, a word consists of five characters and one space for a total of six characters. All punctuation, spacing and control characters must be counted because they must be transmitted.

The conversion from bits per second to words per minute can be made using the following formula:

$$\text{Bits Per Second} = \frac{\text{Words/Min} \times \text{Char/Word}}{60 \text{ Seconds}} \times \text{X Bits/Char.}$$

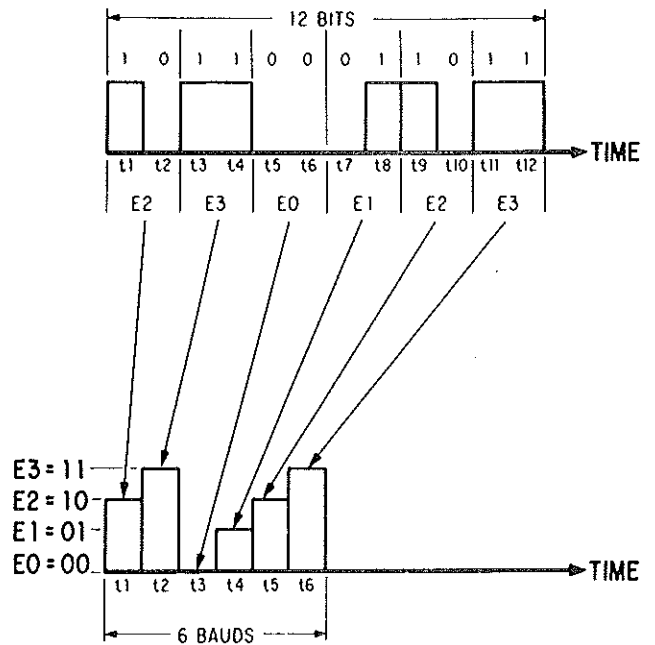

Figure 13. Bauds vs. bits

With this formula, and knowing that the Baudot Code has 7.42 Bits/Character, the bit rate of 60 word per minute teletypewriters service can be calculated as follows:

$$\begin{aligned}
 \text{Bits Per Second} &= \frac{60 \text{ Words/Min} \times 6 \text{ Char/Word} \times 7.42 \text{ Bits/Char}}{60 \text{ Seconds}} \\
 &= \frac{360 \text{ Char/Min} \times 7.42 \text{ Bits/Char}}{60 \text{ Seconds}} \\
 &= 6 \text{ Char/Sec} \times 7.42 \text{ Bits/Char} \\
 \text{ANSWER} &\approx 45.45 \text{ Bits/Second}
 \end{aligned}$$

Note: For convenience these figures can be rounded off to (7.5) and (45).

When the bit rate is known, words per minute (WPM) can be determined from the formula:

$$\begin{aligned}
 \text{WPM} &= \frac{\text{Bits/Second} \times 60 \text{ Seconds/Min}}{\text{Char/Word} \times \text{Bits/Char}} \\
 &= \frac{45 \text{ Bits/Second} \times 60 \text{ Seconds/Min}}{6 \text{ Char/Word} \times 7.5 \text{ Bits/Char}} \\
 \text{ANS.} &= 60 \text{ WPM}
 \end{aligned}$$

CIRCUIT CONCEPTS

Signal Representation

Figure 14 shows a sine wave representation of a simple signal.

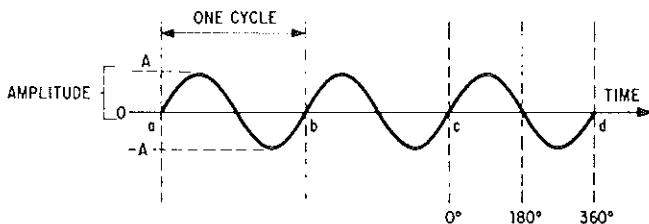

Figure 14. Sine wave

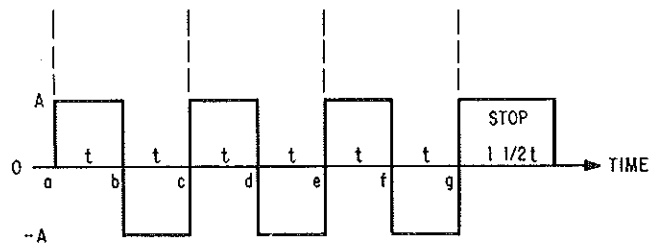

Figure 15. Digital representation of a sine wave

In Figure 15, each half cycle of the sine wave is represented by a signal having a value of plus/minus A. The distance "t" represents the time duration of a single excursion. This time is called a baud. A stop signal as used in Baudot Code has a length 1 1/2 times that of the information signal. The stop signal in the transmission of ASCII requires a length equal to that of the data.

Notice from the two diagrams, there could not be more than 2 bits represented by one cycle. Two bits per cycle is the theoretical maximum information content of a wave.

Original telegraph signalling or transmission placed only one signal element on a transmission line. This signal-no signal type transmission is called uni-polar and is shown in Figure 16. In telegraphy, the presence of a signal is called a "mark" and the absence of signal a "space". With unipolar signalling line interruptions are identified as "spaces". Accordingly, this method gave way to Bipolar signalling which always had signal on the line unless a line interruption occurred. These signals (see Figure 17.) have opposite polarities to distinguish "zero" from "one" bits or marks from spaces. Modern communication terminals and data transmission devices use both types of signalling.

A bit has been previously defined as the smallest unit of information. Its content can be one or zero. Signalling speed is defined as the number of signal

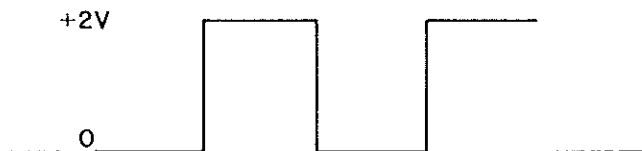

Figure 16. Unipolar signal

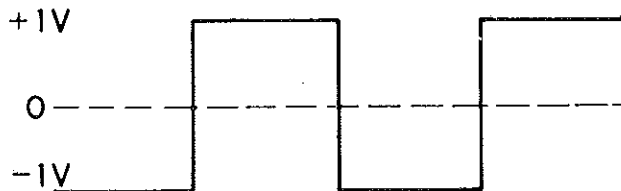

Figure 17. Bipolar signal

elements sent along a transmission medium per unit time. One bit per signalling element was previously assumed. More sophisticated systems which can and do have signalling elements containing several decisions are possible; thus the difference between bits and bauds.

Modulation

The process of impressing a signal on a carrier wave is known as modulation and the result of this process is called a modulated carrier wave. The reverse process, in which the signal is retrieved from the modulated carrier wave is called demodulation. The information signal impressed upon the carrier wave is called the baseband signal. There are various methods of modulating carrier waves, but two of the most commonly used are amplitude modulation and frequency modulation.

Amplitude Modulation

In amplitude modulation (AM), the amplitude of the carrier wave is varied in accordance with the variations of the intelligence signal. The degree of difficulty in modulation depends upon the nature of the signal. In Figure 18 a carrier wave A is 100% modulated by a digital signal B. The modulated carrier C is simply a sequence of tone bursts with the tone representing "one" bits and absence of tone representing "zero" bits.

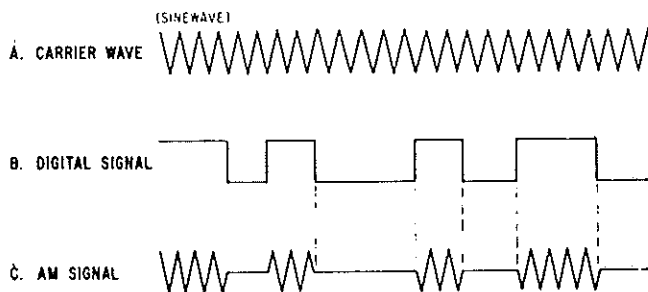

Figure 18. Amplitude modulation

Frequency Modulation

In frequency modulation (FM), the frequency of the carrier wave is varied in accordance with the variations of the baseband or modulating signal. The amplitude of the carrier wave does not change - only its frequency changes. In Figure 19 a carrier wave A is modulated by a digital signal B. Note the modulated carrier wave C is of constant amplitude but of two different frequencies. With FM, there is signal on the line at all times. If bipolar signalling is employed with FM, the carrier will be shifted to a frequency both above and below its unmodulated frequency. This type of FM is called frequency shift signalling or frequency shift keying (FSK). In FSK, the unshifted carrier tone corresponds to complete absence of signal. The actual change in carrier frequency produced by the baseband signal is called frequency deviation. An example of frequency deviation in low speed digital transmission systems is about 100 cycles per second.

Phase Modulation

In phase modulation, the phase of the carrier wave is varied by the intelligence signal. From Figure 14 it can be seen one complete cycle of a wave represents 360 degrees of phase. For simplicity, consider a phase change as being analogous to advancing the carrier wave a certain number of degrees past a reference point. With phase modulation, it is the amount of change in phase - not the point at which it changes that conveys the intelligence. Phase modulation, unlike AM & FM, can be used only with digital transmission systems. This is because phase change detectors can detect only large abrupt changes such as those produced by digital signals. The modulated carriers for these most commonly used modulation schemes are compared in Figure 20.

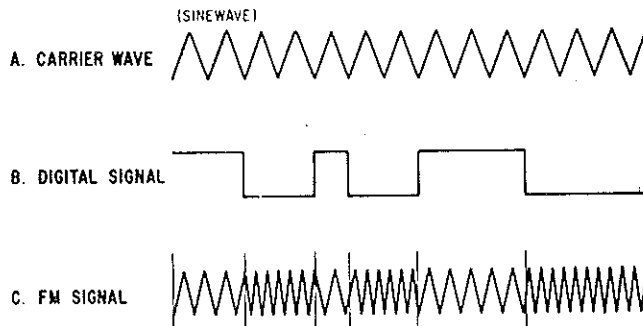

Figure 19. Frequency modulation

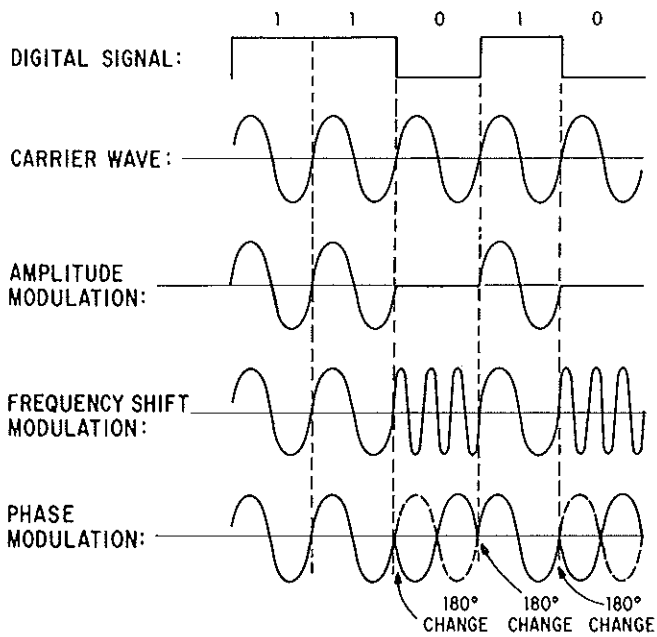

Figure 20. Modulation techniques

Pulse Modulation

Other transmission systems may use a special form of modulation called pulse modulation. The several types of pulse modulation are shown in Figure 21. Pulse modulation consists of sampling the baseband signal at regular intervals and converting the sample results into one of the following signal pulses for transmission.

Pulse Amplitude Modulation (PAM) - each sampled pulse is uniform in width and time position but may vary in amplitude.

Pulse Width Modulation (PWM) - each sampled pulse is of constant amplitude and time position but may vary in width.

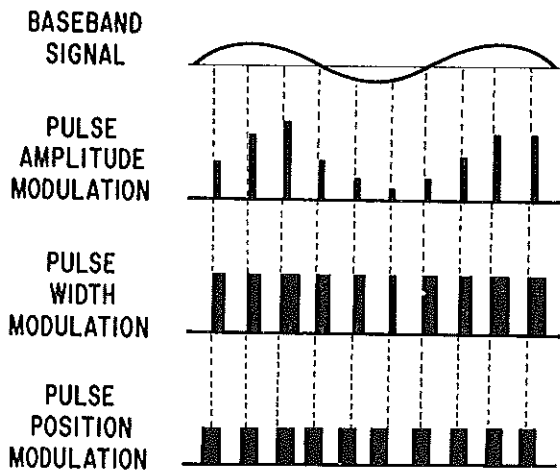

Figure 21. Pulse modulation methods

Pulse Position Modulation (PPM) - each sampled pulse is of the same width and amplitude but its pulse time position with respect to a uniform time scale varies.

A variation of pulse amplitude modulation is called pulse code modulation (PCM). In this modulation technique the sampled pulses of varied amplitudes are converted to a 7 bit code to represent the absolute amplitude of each pulse. These digital codes are then transmitted.

Multiplexing Techniques

Transmission systems also can utilize the principle of multiplexing, which means dividing a communication media into pieces or slots each capable of carrying information from a separate input. Multiplexing may take place by time or frequency division.

Frequency Division Multiplexing

Frequency division is used in the parallel mode of transmission, with each channel assigned a specific frequency band. The carrier systems are a form of frequency division in that several voice channels are assigned discrete bands or parts of a carrier systems total frequency spectrum. By using the principle of frequency division, it is possible to have a leased or privately owned voice grade line provide a number of low speed lines. (See Figure 22).

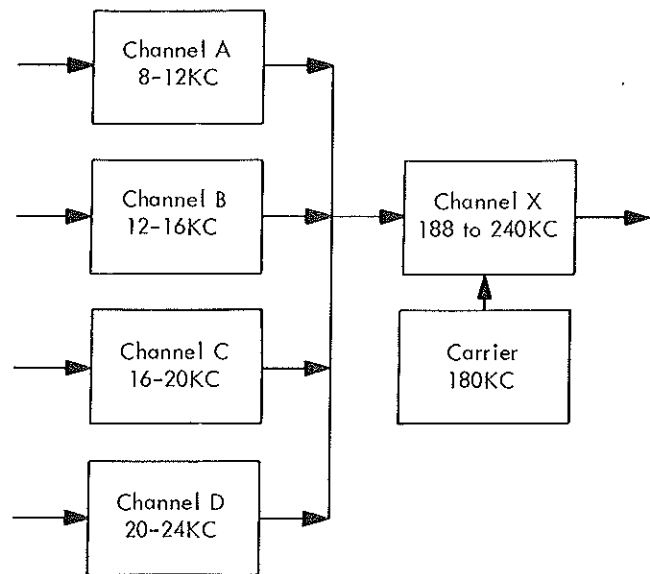

Figure 22. Frequency division multiplicity

Each low speed line is allocated its own individual frequency. This allows independent simultaneous transmission on each frequency band.

Time Multiplexing

Time multiplexing is the dividing of the medium into discrete time slots, each of which is capable of carrying information from a different input.

An example of time multiplexing is shown in Figure 23. Several lines are supplying simultaneous and independent signals to a scanning device which then assembles a composite signal on a single line. To avoid distorted pulse shapes on the low speed lines a small buffer is sometimes used to provide a solid signal.

The advantage of such an arrangement is that a single line could service multiple lines terminating at the scanning device.

Notice that the character assembled from the low speed lines is a composite made up of one bit from each of the automatically scanned lines. This composite character is then transmitted to the remote end and automatically demultiplexed, i.e., the bits are distributed to low speed lines. This technique is sometimes referred to as concentrating by time division multiplexing. In the event a computer is being used at the remote end the method of transmission (i.e., time-multiplexing or straight telegraph) could not be detected by the individual programming the system.

Circuit Limitations

Frequency Distortion

Attenuation is the loss in intensity or amplitude of a signal as it travels in a transmission medium. The loss is proportional to the line's impedance which will vary with frequency. At higher frequencies, a line will have greater impedance and consequently

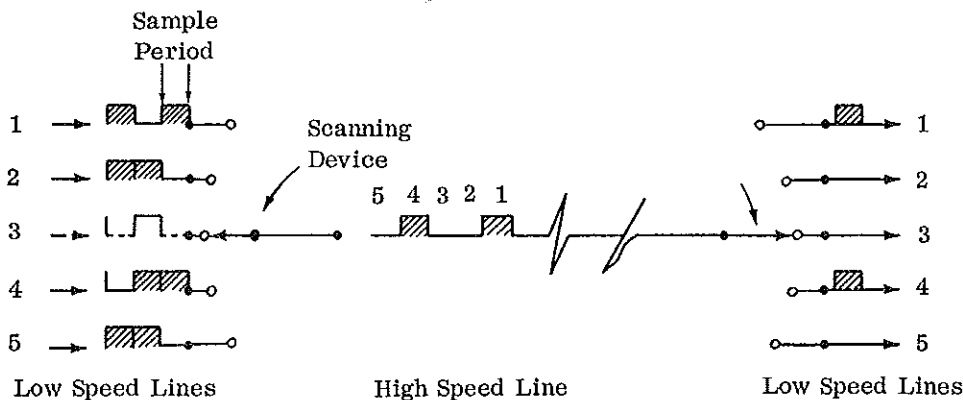

Figure 23. Time multiplexing

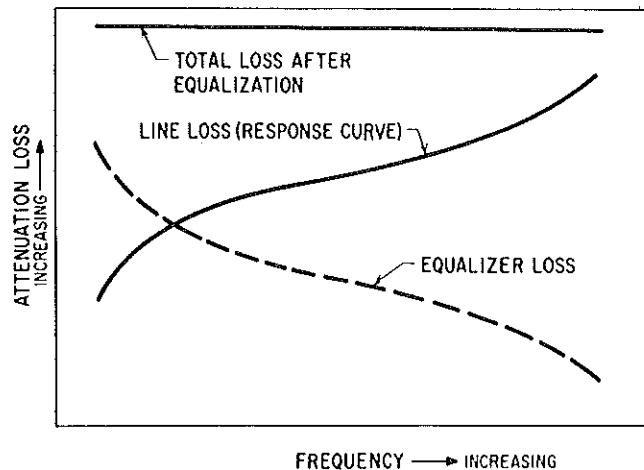

Figure 24. Frequency distortion

greater losses. This variation of loss with frequency is called attenuation distortion, amplitude distortion, or frequency response. Figure 24 shows a response curve for a communication circuit.

It is desirable to have all frequency components of a signal suffer the same loss. When this happens, the circuit is said to have a flat response curve. A flat response curve (see Figure 24) can be achieved by inserting a device called an attenuation equalizer into the circuit. The equalizer is a network of resistance, capacitance and inductance having attenuation characteristics inverse to those of the line.

The attenuation equalizer adds relatively large losses at low frequencies and only slight loss at high frequencies. The total loss, measured from end to end of a circuit, is called the net loss. For a voice channel, net loss is usually measured at a reference frequency of 1000 cycles per second.

Delay Distortion

Transmission time or absolute delay is the time it takes from transmission to reception of a signal

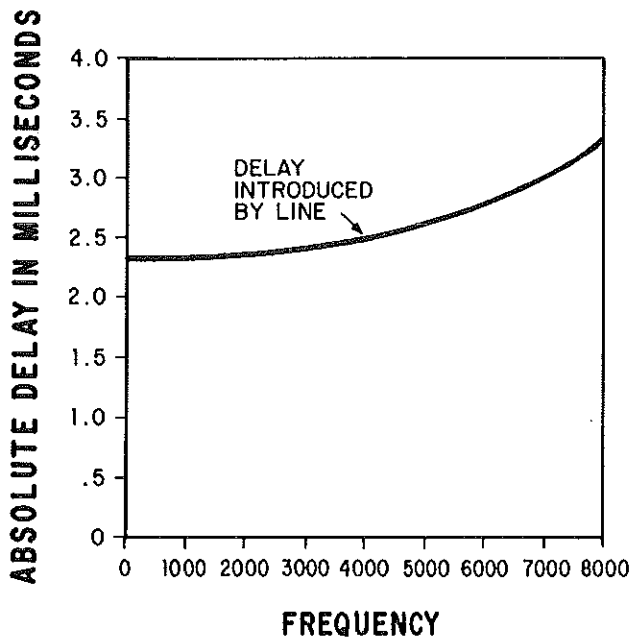

Figure 25. Delay distortion

over a communication channel. Electrical tones or frequencies, don't all travel at the same speed. The difference in speed permits some parts of a signal to reach the receiver ahead of others. This variance with frequency, shown in Figure 25 is called delay distortion and is a serious limitation in circuits used for data communication.

Because a square wave signal is composed of many different frequencies, the edges of the signal begin to distort as the wave travels to its destination. This distortion may cause the receiving equipment to ignore this distorted wave as an information signal.

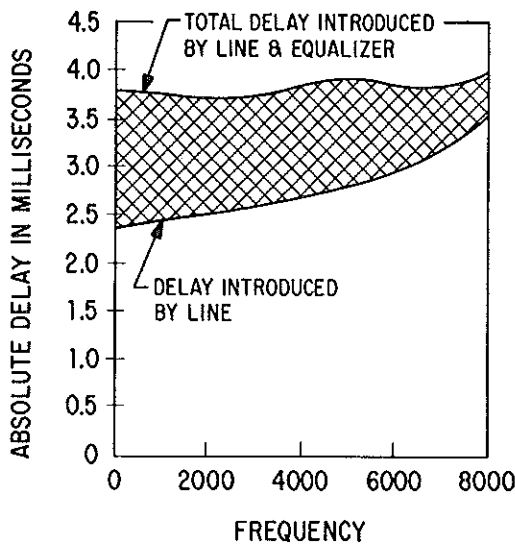
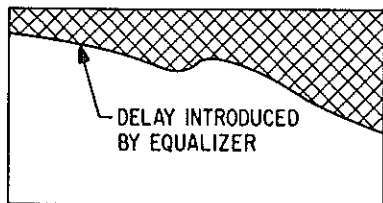

Figure 27. Effect of delay equalizer

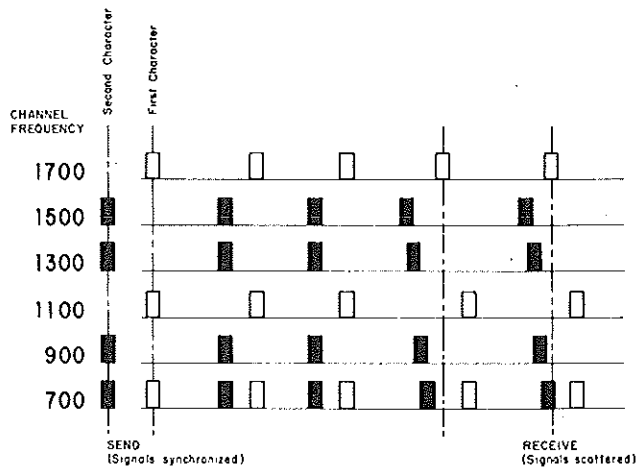

Figure 26. Effect of delay distortion

This limitation is even more severe when transmitting in the parallel mode, as shown in Figure 26. Figure 26 also gives a clearer representation of delay distortion. Although this figure shows data signals in pulse form, keep in mind the pulses are actually tones or bursts of different frequencies. At the receiving location, because of delay distortion, the low frequency signals of the second character could be interpreted as belonging to the first character. This would be an error.

The solution to the delay distortion problem is similar to that of attenuation distortion. Networks, called delay equalizers, are inserted into the line. Their opposite delay characteristics, when added to the delay of the line, will cause an overall response approximating a flat curve or a constant value. The characteristics of a delay equalizer and its effect upon a transmission line are shown in Figure 27.

Noise Signals

Noise is the name given to unwanted signals which appear on a communication channel and distort or mask the baseband signals. Noise can come from terminals, switching equipment, or the communication channel itself. One of the most common types is noise induced by high voltage power lines. Other noise causes are cross talk currents from adjacent channels and unbalanced line conditions.

White Noise

This type of noise usually maintains a constant level and is called "steady" or "white" noise. If the "white" noise level is relatively low, it ordinarily causes no difficulty or errors in data communications. Figure 28 shows a digital signal A impressed upon a communication channel having a white noise B. The signal C will be unaffected and correctly identified at the receiver as long as the noise level remains below the signal detection level X.

Impulse Noise

There is another type of noise, however, which sometimes cannot be heard but which can cause great difficulty in data communications. This is

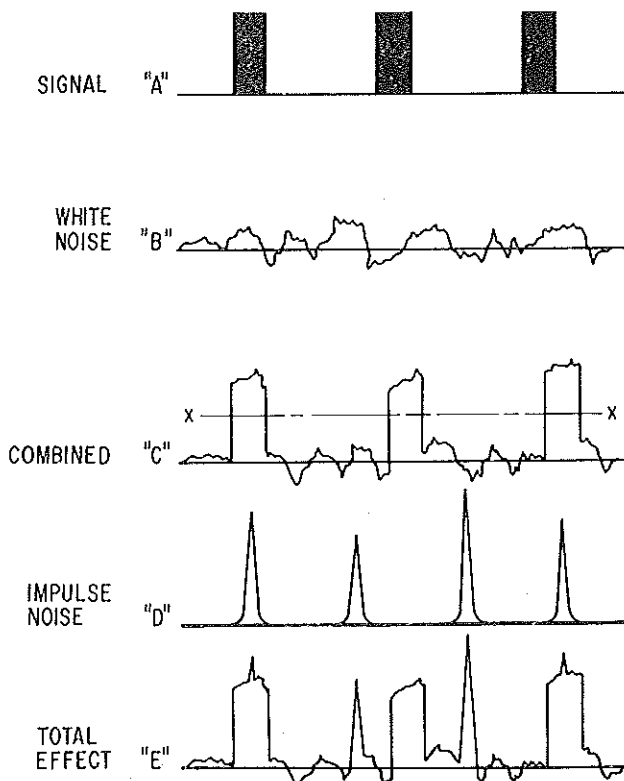

Figure 28. Effect of white noise

called impulse noise (D) and can be caused by lightning, switching equipment or maintenance personnel. Impulse noise, as its name implies, takes the form of large narrow spikes or impulses which can either obliterate or negate a data signal (E). Figure 28 illustrates impulse noise. Impulse noise limitations are expressed in both magnitude and rate of occurrence. A typical common carrier specification would be about 70 peaks per hour as a tolerable occurrence rate.

The term "signal to noise ratio" (S/N) is used to express noise levels. Its unit is the decibel (db) and it is measured on a logarithmic scale from a standard or reference signal level.

Effects of Errors on Performance

Considerable effort has resulted in a family of statistics concerned with actual error occurrence during data calls on the exchange telephone network. Although impossible to predict, an average rate of one error bit to every 10^4 to 10^5 bits transmitted, can be considered representative of average performance. The important point to remember is these are averages resulting from thousands of transmissions and for any one call performance may deviate drastically. As expected, it was found that error rates went up as the bit rate was increased. Error rates also were found to be higher during the busy times of the day, indicating error rate is also a function of switching activity.

Errors may be classified into two types: the random or intermittent type and the burst or long series of errors type. The random error is the most troublesome because it can occur at any time. The burst errors usually are detected easily because entire blocks of information are received in error.

The effect or "costliness" of an error must be evaluated before error controls are considered. For example, teletypewriter communication is ordinarily in the form of plain message text. Errors in the form of a few misspelled words wouldn't appear to be very costly - especially when compared with the effect of loading a program containing transmission line errors into a computer.

In microwave transmission there usually are five broad band channels in each direction. In addition to these five, there is one spare called a protection channel. Microwave systems are divided in 60 to 100 mile legs (depending upon repeater locations) called switching sections. A pilot or fixed frequency is sent on each channel to insure continuity of service. If the pilot is lost, it indicates that its particular channel is in trouble. The loss in pilot frequency causes the 6th or protection channel to be

switched automatically to replace the troubled channel. The old section can be switched out and the new one substituted in milliseconds. Similar back-up exists in coaxial systems where one protection coaxial is provided for each 3 working coaxial tubes.

The "echo" problem that will be described later is a rather serious one in voice communications. It is solved, however, by inserting high impedance devices called echo suppressors in the line. Under relay control, echo suppressors are inserted about 12 milliseconds after speech in one direction starts and are dropped out 50 to 100 milliseconds after conversation stops. This time required to reverse the direction of transmission is called "turnaround" time. This time interval does not hamper voice communications but does assume sizeable proportions on data channels. The problem is overcome in data communication by removing the suppressors from the line or providing an appropriate (about 500 millisecond) delay in business machines. Echo suppressors also have been modified to disable themselves upon receipt of a special tone (2025 cycles per second) from a data set when exchange data calls are made.

In summary, data signals are subject to numerous "hazards" while traveling in a communications medium. These usually are the result of the many factors mentioned or may even be the result of less significant happenings such as sudden transmission level changes. The problems of errors and error control must be considered in any data communication system.

Error Detection

There are several methods used to detect errors. The two most commonly used are parity or vertical redundancy check (VRC) and longitudinal redundancy check (LRC). Parity may be either even or odd, meaning the sum of the "one" bits for any character or column will always be even or odd depending upon which arrangement is chosen. Figure 29 shows a six bit code arranged for odd parity. The seventh bit is the parity or check bit. The number of information bits in characters 3, 5, 6 X and Y shown are even. To satisfy the odd parity requirement, a bit is simply inserted in the 7th (check) position for each of the characters to change the sum of the "one" bits to an odd number. This is done to all even bit characters. At the receiving terminal, each character is checked for the proper parity. If an odd number of bits are either lost or added, the character received will be in error. The receiver will detect the error, punch special characters, turn on an indicator light and send a

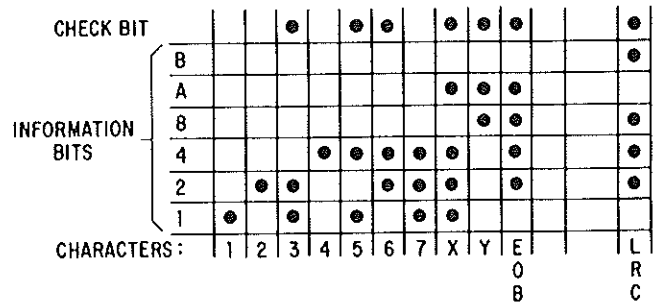

Figure 29. Vertical and longitudinal checking

negative check answer indicating errors were detected.

With longitudinal checking, each transmitting and receiving terminal generates a separate count of "one" bits for each of the bit positions of the code. This count, when completed, results in an LRC character which could be considered to be a horizontal parity bit for each channel. For checking purposes, data are grouped into a unit containing a specified number of characters. This unit is called a block and may vary in length, depending upon the application. After each block of information, indicated by an EOB (End of Block) character, the LRC character generated at the transmitter is sent to the receiver. It is compared to the LRC character generated by the receiving terminal. If they are equal, a positive response is sent back and the next information block is transmitted. If they are unequal, a negative answer is sent back to the transmitter. On receipt of a negative answer, many terminals will retransmit a block two times in an attempt to automatically eliminate errors. If the three attempts are unsuccessful, the system will stop. The End of Block character can be placed anywhere in the text of the message. When data is to be printed it often is located at the end of each printing line. Note in Figure 29 when adding in either a vertical or horizontal direction, the sum is always an odd number. If it is not, the received information is in error. Check this for yourself by adding or removing a single bit. Try it with 2 bits, etc. Another form of checking is cyclic or polynomial checking. When compared with VRC & LRC, it is considerably more complex and as a result, capable of detecting almost all errors.

Cyclic checking works similar to LRC. Instead of generating a check character by adding the bits in each data channel of a block, it divides all the serialized bits in a block by a predetermined binary number. The remainder of this division is the check character which is sent and compared with the check character obtained in similar fashion at the receiving terminal.

Error Correction

Checking is a means of detecting errors only. Some terminals have the ability not only to detect errors but to correct them. Figure 30 shows the same set of characters previously shown but with an error introduced. The error is the addition of an unwaranted "one" bit in the character "four". The receiving terminal will automatically recognize the vertical and horizontal "no check" paths shown by the dotted line. Their intersection is the bit in error and it will be negated or reversed.

Error detection and/or correction take time. Rated or nominal speed has been defined as the highest speed at which a terminal can operate. The effective speed reflects the added time necessary for checking and control functions and must always be considered. If errors are being received, several retransmissions would be required and effective speed would be further reduced.

Effective speed for a representative terminal is calculated below and is based on a rated speed of 135 BPS and a block equal to one seven inch writing line:

# of characters in a block	= 7 inches x 10 characters/ inch = 70 characters
# of Bits in a block	= 70 characters X 9 bits/ character = 630 bits
Time to transmit a block	= 630 bits ÷ 135 bits/ second 4.7 seconds
Effective Speed	= 630 bits ÷ total time (transmission + checking time) = 630 bits ÷ (4.7 sec. + 0.3 sec) = 630/5
Effective Speed	= 125 bits/second

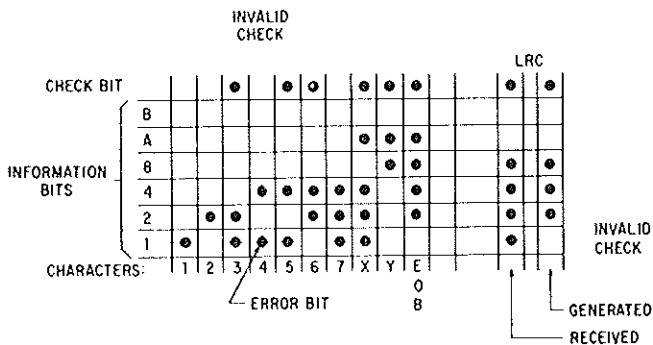

Figure 30. Error correction

Should average error performance be experienced, one out of 15 blocks would be retransmitted which would reduce the effective speed to about 110 bits/second. In high speed systems where start and stop times become significant, effective speed may be as low as one-half rated speed.

COMMUNICATION CHANNELS

A communication channel has been defined as an electrical path to facilitate the transmission of intelligence between two or more points. The provision by common carriers of proper communication facilities (both number and electrical design) is complex and not easily understood. Rather than going into the detail of "How" and "Why", facilities are furnished we will briefly review the physical plant or facilities that are now used in providing communication channels. Appendixes A1 & A2 contain some of the technical background on Basic telegraphy and telephony.

As the telegraph and later the telephone communications companies grew, numerous circuits of varying length and electrical characteristics were added throughout the nation. As a result, present communication facilities consist of various sized wires and systems; some as new as several months, and others as old as sixty or more years.

Original facilities generally used large wire which was required to overcome electrical losses, and with these facilities communication was usually loss-limited to distances of less than several hundred miles. All electrical circuits contain properties of resistance, inductance and capacitance which cause the diminishing of a signal as it travels in a communication line. The reduction in strength of a signal in a transmission line is called attenuation. By placing small inductors (coils of wire) in voice transmission lines at specific intervals, the added inductance offsets the capacitive loss and overall attenuation is reduced. These coils are called "load coils" and their insertion is called "loading" a line. Although loading a line improves its attenuation characteristic it has an adverse affect on the delay distortion. Loading of lines increased the practical voice transmission range to almost 2,000 miles. About 1915, vacuum tubes and amplifiers were introduced and the era of modern communications began.

The basic unit or communication channel today is a voice grade channel which has been defined as having a nominal bandwidth of 4000 cycles. In reality, however, the useable frequency range is about 300 to 3000 cycles. The space lost on the edges creates a "guard space" which helps avoid interference. The resultant 2700 cycles is called

the useable bandwidth. The nominal bandwidth of a voice grade channel (4 kilocycles) may lie anywhere in the frequency spectrum. It could be identified by the band between 12 and 16 kc, 164 and 168 kc, 1491 and 1495 kc or at any frequency range as long as the bandwidth is 4 kc.

As the need for communications increased in the post World War II era, so too did the cost of providing communication channels. The problem of increased costs was alleviated by greater use of "Carrier" systems which permitted several conversations to be sent on only one circuit. These systems use a high frequency wave to "carry" information. The wave is descriptively called a carrier wave. Systems are commonly identified by alphabetical letters such as N-Carrier, L-Carrier, etc. and may vary in capacity from only a few to several thousand voice grade channels.

In such systems, voice information is superimposed on a high-frequency wave which "carries" the information to a receiver. When the information signal is imposed upon a carrier signal, it is relocated to a specific slot in the frequency spectrum.

Figure 31 shows a voice band signal (0-4 kc) shifted by a 5 kc carrier wave to the 5 to 9 kc range. This permits a second voice band signal to occupy the original signals 0-4 kc slot and both signals can then be sent on a channel having a 10 kc bandwidth. Many telephone cables can do this on one pair of wires. Notice the results of this kind of modulation are additive -- the modulation product (5-9 kc band) is the sum of the 5 kc carrier and the original signal (0 - 4 kc). A difference frequency is also present but this unwanted signal is eliminated by filtering.

Figure 32 illustrates the effect which carrier systems have upon furnishing circuits between two cities. Using only two of the existing 12 circuits, a six channel carrier system will provide $2 \times 6 = 12$ channels making a total of 22 available between

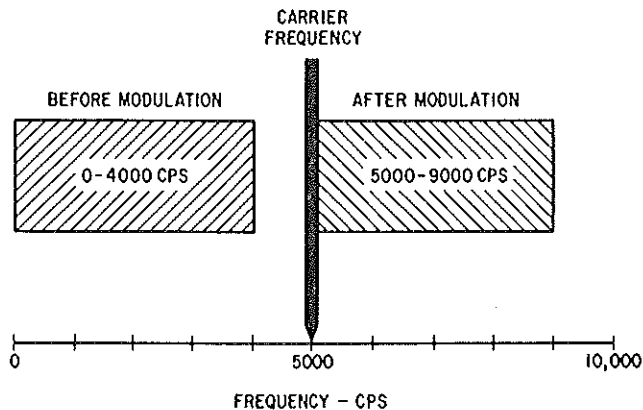

Figure 31. Effect of modulation

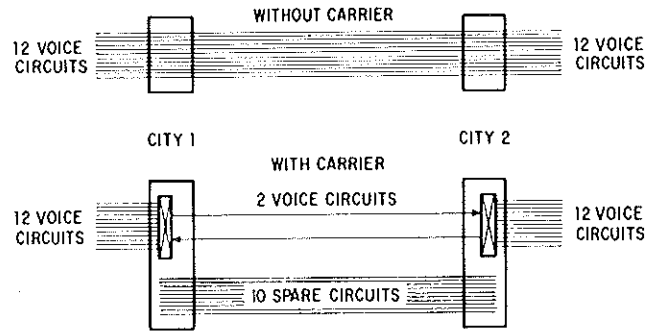

Figure 32. Carrier systems and circuit provisions

cities A and B. If all 12 pairs were used for carrier transmission, a total of 72 channels could be obtained.

The use of carrier systems or systems embodying the use of a carrier wave is commonly found in modern communication. Figure 33 shows some of the assigned use of the frequency spectrum. Commercial radio utilizes a high frequency carrier wave to transmit broadcasting information to radio receivers.

Tuning is merely matching the radio receiver to the frequency of the desired transmitted carrier wave and then separating the intelligence signal from the carrier by demodulation.

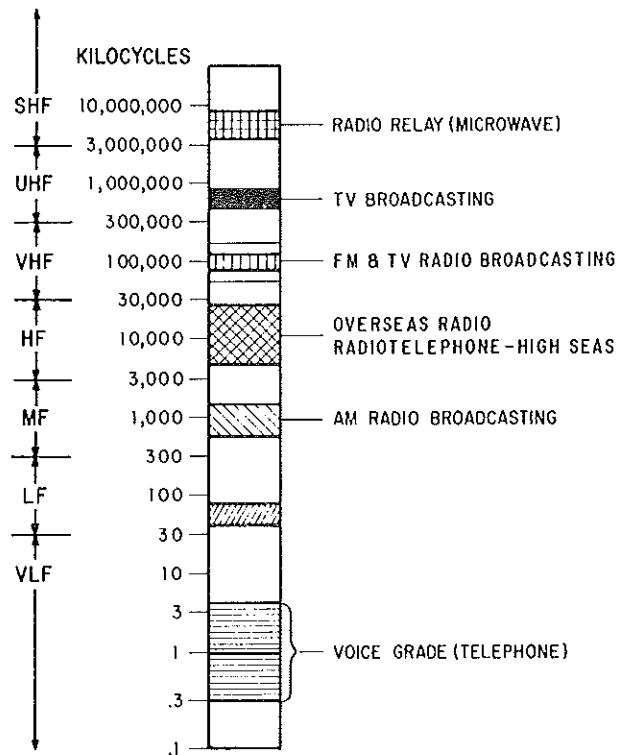

Figure 33. Frequency spectrum

TELEGRAPH GRADE CHANNELS

Channels for teleprinter service are called Telegraph Grade and are considered low speed. These channels were designed to handle a maximum of 75 bits/second. Early telegraph lines were entirely dc pulse signalling. As demand grew, voice frequency carrier telegraph was developed for use on longer channels, so that now telegraph channels use dc signalling only short distances and, of course, between each machine and its carrier line.

Carrier telegraph systems use the same principles as carrier systems already discussed. In this system, however, the process is expanded and one voice channel is divided into 18 or more telegraph channels. Derivation of channels from a higher grade facility is called channellizing or multiplexing. Telegraph signals are also subject to attenuation and other deteriorating effects of the line. DC telegraph channels contain devices known as regenerative repeaters which overcome these deteriorating effects by reshaping and retiming the pulses of each character. The regenerative repeaters may be electromechanical or electronic. Either kind will work only with a specific start-stop code. Lines equipped with these repeaters are "code sensitive", meaning they will transmit only the specific start-stop code they are designed for at a specific speed. Today the major common carriers are removing these regenerators and replacing them with bit regenerators which are code and speed insensitive.

SUB-VOICE GRADE CHANNELS

Like most telegraph channels, sub-voice grade channels are usually derived from voice facilities. They lie between telegraph and voice grade facilities capability and generally in the 100 to 180 BPS range. The common carriers offer two channels in this range with 150 and 180 BPS maximums. This grade channel may not be code sensitive (can handle any code) and is restricted to serial transmission. There is no voice communication with sub-voice grade channels.

VOICE GRADE CHANNELS

In the introduction to channels and channel derivation, a definition of voice grade channels was given and the effects of attenuation were discussed. To overcome attenuation effects during communication, the information signal carried over the usable channel bandwidth (300 to 3000 cycles) must be amplified or boosted at regular intervals. A general understanding of a voice channel is helpful because so many data

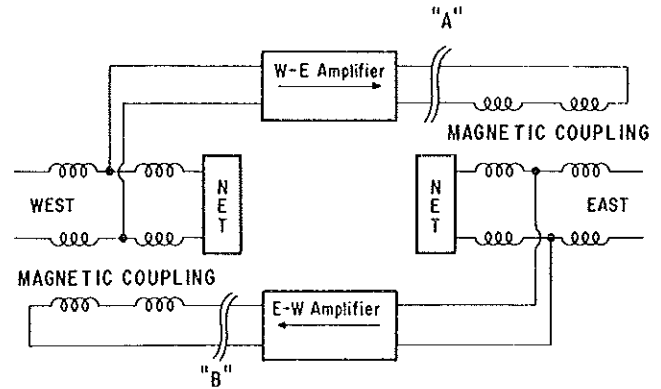

Figure 34. Electromagnetic amplifier connection

communicating devices operate on voice facilities. Voice channels between cities in the public telephone system are often called toll circuits and these same facilities are also used as required for voice grade requirements.

Line Amplifiers

Amplifiers are signal boosters which make up for losses in the transmission medium. They are directional or one-way devices, and if they are connected directly in a circular loop the boosted signal goes round and round and is constantly boosted until the amplifiers oscillate or "sing". A similar effect is noticed when the volume control is turned too high on a public address system.

To avoid the "singing" problem and maintain the proper amplifier effect, the physical line connection is severed and made electromagnetically as shown by Figure 34.

Two-Wire Circuits

A two-wire circuit having amplifiers inserted in this manner is said to have "double-tracked" repeaters or amplifiers. This arrangement works very well and is commonly used.

If further amplification is required, additional repeaters could be "double-tracked" in much the same way at necessary points along the channel.

Four-Wire Circuits

The West-East circuit in Figure 34 could be lengthened at "A" and as two-wire circuit, additional amplifiers could be inserted in the line. The same could be done with the East-West circuit at "B" and upon completion, a separate path would exist in each direction. Each path would represent one half the total circuit and would be unidirectional. This arrangement of facilities is called a 4-wire circuit. Figure 35 demonstrates

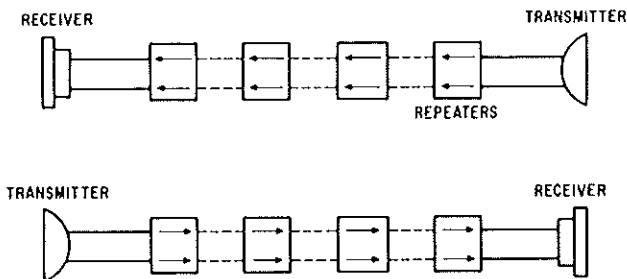

Figure 35. Principle of a 4-wire circuit

the principle of a 4-wire circuit or its equivalent. Most intercity voice grade channels today are four wire equivalent.

The line connecting a communications customer to the local common carrier office is called the "local channel" or "local loop". It may be either a 2-wire or a 4-wire facility. When voice grade local channels are extended beyond a specified distance, they, like long voice channels are generally "loaded" to reduce transmission losses. When a two-wire local channel is joined to a 4-wire circuit, it is done electromagnetically by a hybrid coil called a 4-wire terminal set.

Figure 36 is a general schematic of a 4-wire toll circuit showing the local channels as 2-wire local loops. The "nets" indicated are balancing networks which are used to balance the line to reduce reflection losses, eliminate "singing", and maximize circuit gain.

While using the telephone, you may on occasion have noticed peculiar "ghosts" or echoes of your voice on a telephone line - particularly on long distance telephone calls. These echoes result from the reflection of your voice at the farthest 4-wire, 2-wire circuit juncture or intersection and the intensity of the echo will vary with the circuit imbalance.

The reflected signal returns to the originator via the receiving path of the circuit and is amplified sufficiently to cause annoyance. Actually, not one but a family of echoes may be produced as shown by Figure 37.

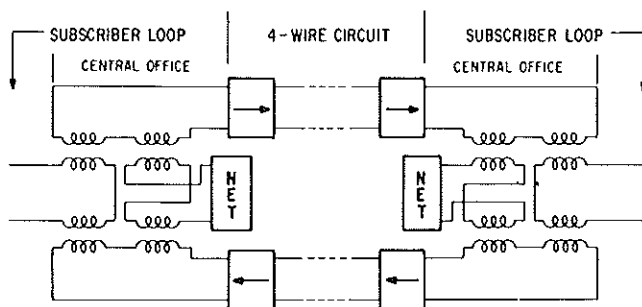

Figure 36. 4-wire circuit with 2-wire termination

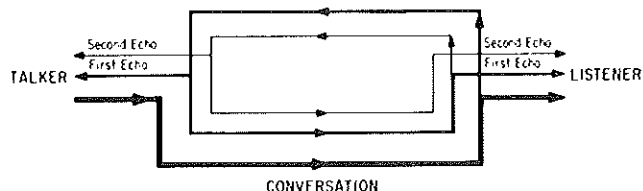

Figure 37. Echoes in a 4-wire circuit

Long 4-wire circuits are equipped with devices called echo suppressors which have the ability to automatically insert a passive high impedance in the return path. This impedance effectively short circuits the return path, and eliminates the echo as shown by Figure 38. Because 4-wire circuits have 2 separate paths or directions, a suppressor is required on each side of the line. Echo suppressors operate under control of relays and will change from "on" to "off" and vice versa with the direction of conversation. The time interval required for the suppressors to switch from one state to the other is called "turn around time" and is commonly about 50 milliseconds. The two suppressors associated with a 4-wire circuit always must be opposite or the inverse of each other in state to avoid blocking of communication in both directions at the same time.

CONDITIONED VOICE GRADE LINES

There are three types of channels of a grade similar to those furnished for voice grade channels. They are designed to meet certain specifications of attenuation, delay and noise. This is called conditioning. Most common carriers offer two or three levels of conditioning which incur additional charges at each station.

When voice grade channels characteristics can be held to particular specifications, certain types of modulation and/or higher data speeds can be utilized.

BROADBAND CHANNELS

The voice grade channel has been considered to be the basic building unit in carrier systems. This

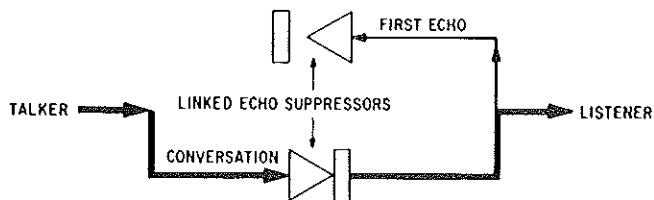

Figure 38. Principle of echo suppression

building block is commonly called a channel or voice equivalent. If 12 voice channels in a carrier system are terminated in a special way as one single channel 48 kc wide, rather than a group of 12 channels, the resultant facility is called a broadband channel.

With modern technology, channels can be derived on conventional wires having bandwidths of 8, 12, 16, 24, and 48 kc. Any channel wider than voice grade is often considered to be a broadband channel. The terms wide band and broadband, however are used synonymously. Common carriers offer broadband channels in both leased and switched mode, as described in the next section.

Given physical or radio facilities having greater capacity, wider channels or 96, 240 and 1000 kc (1 megacycle) can be developed. These are the most common widths used by communication common carriers. For data transmission the common carriers reserve the right to do all modulating or conditioning of signals for transmission on the broadband channel they provide. Thus in general the communication companies provide the modulating devices for use on a broadband channel.

SPECIAL CHANNEL FACILITIES

The 48 kc and 96 kc broadband channels can be provided over specially conditioned 4-wire circuits. Carrier techniques are used to translate these signals to a higher frequency slot to take advantage of transmission characteristics. However, the two wider band channels (240 kc & 1 mc) cannot use conventional wires and must use special facilities. High frequency waves tend to radiate in all directions into space. These radiated waves not only represent losses in signal power but they also cause interference in adjoining communications channels. Because of these problems, new techniques were developed which solved the loss-interference problem and facilitated broadband communication systems with greatly increased capacities.

These techniques have been in use for some time and yet the general public is less aware of these than the "normal" transmission by wire concepts. Two of the most familiar techniques are coaxial cable transmission and microwave transmission. Each of these require special facilities and a short description of each is found in Appendix A.

COMMUNICATION SERVICE OFFERINGS

There are two basically different ranges that common carriers offer in communication channels. One is called Public or Exchange Service and consists of subscriber lines connected to a switching system. It is "public" in the sense that all customers are connected to the same system; and it is "exchange" in the sense that calls are placed by the originator and connection to a destination lasts only as long as needed. Usually the cost of exchange service consists of tolls based on distance and length of connection, and a monthly service charge to maintain system access. Obviously one subscriber station can place a call to any other station whether or not it is the same customer.

The other is Private Line Service or Channels, which consist of full time leased point-to-point or multipoint lines connecting only locations belonging to one customer. Usually the cost of a Private Line consists of monthly rental based on length and type of lines. For this purpose, each line consists of two or three separately priced parts, as shown in Figure 39. Some line offerings combine the function of local loop into one channel terminal charge for each station. The pricing configuration of lines has no relationship to the way the physical channel will be routed. Private line connections are dedicated and communications are, therefore, only between points connected to the same line. Such lines may be interconnected by switching equipment to provide a private version of an exchange system, or may be connected to common processing equipment to provide data processing service to many such lines.

Distance measurement for public exchange and private line purposes is defined in a variety of ways by the common carriers, but allow an attempt to mechanize the measurement of airline miles so that the mileage between any two points will always be the same. For public exchange mileage measuring, Western Union has divided the domestic U.S. into rate "squares" whose centers are roughly 50 miles apart (FCC Tariff 232). Each square is numbered, and the arithmetic difference between any 2 squares numbers is translated in a table to airline miles. AT & T has developed a "V & H Coordinate" system (FCC Tariff 255) for all Bell System services and most telephone companies concur with it. This system overlays the U.S., Canada and Mexico with a grid system whose lines are about 0.3 mile apart. Western Union also uses this method for determining the private line mileage. Both Western Union and AT & T have created long lists of locations and their corresponding rate square number or V & H Coordinate, which can be found in the above tariffs.

To determine INTEREXCHANGE Channel mileage by the V & H Coordinate method between any two points it is only necessary to determine the V & H Coordinates of the points from the tariffs and solve the following formula.

d = distance in miles

$$d = \sqrt{\frac{(V2-V1)^2 + (H2-H1)^2}{10}}$$

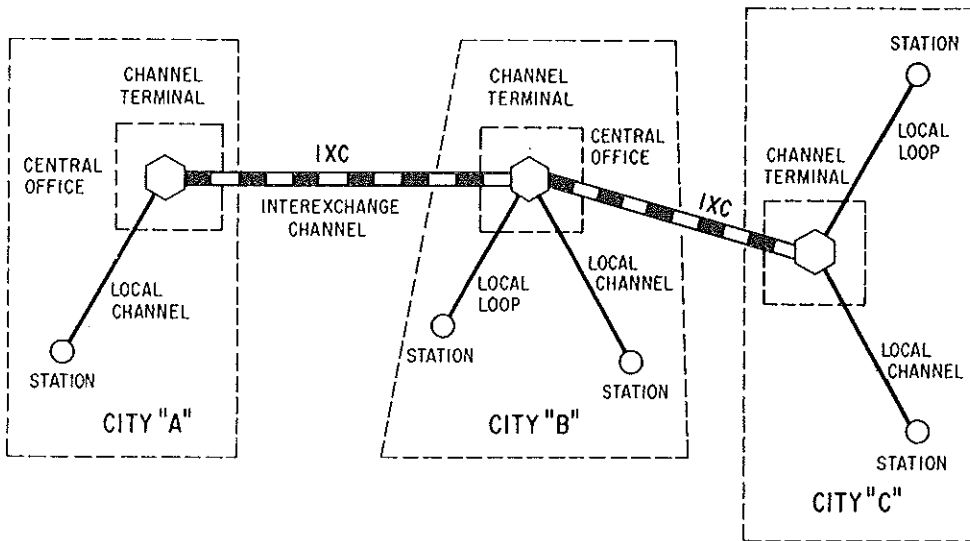

Figure 39. Component parts of a private line

*Station arrangement
channel terminal
and interexchange channel
length*

*P. 16
practice problem*

The coordinate or grid system has been so chosen that the distance represents the airline mileage between points 1 and 2 which can be used in the calculation of line charges.

Multipoint Interexchange Channel pricing is also based on airline mileage as was the two point service. The charges however, are based on a "minimum tree" or the shortest total distance of all the possible ways the various stations may be interconnected. As before the selection of the shortest route for pricing may be independent of the way the circuit is routed. Figure 40 is an example of a typical multi-point private line channel and illustrates how airline mileage is determined for pricing purposes. In the example the distance calculations are already completed so that all that remains is the trial and error method of determining least distance. In the example, arrangement four provides the interconnection with the lowest total mileage.

Based on this arrangement each IXC must then be priced separately. The mileage is not just

applied once on the total channel distance of 1630 miles but rather on the three separate links.

380 mile link	250 miles @ \$1.21	= \$303.00
	(380 - 250) miles @ .605	= <u>79.00</u>
	Total	\$382.00

750 mile link	250 miles @ \$1.21	= \$303.00
	250 miles @ .605	= 151.00
	250 miles @ .484	= <u>121.00</u>
	Total	\$575.00

500 mile link	250 miles @ \$1.21	= \$303.00
	250 miles @ .605	= <u>151.00</u>
	Total	\$454.00

GRAND Total = \$1411/
mo.

NOT - one
1630 mile line!

250 miles @ \$1.21	= \$303.00
250 miles @ .605	= 151.00
500 miles @ .484	= 242.00
630 miles @ .424	= <u>267.00</u>
Approx.	\$963.00

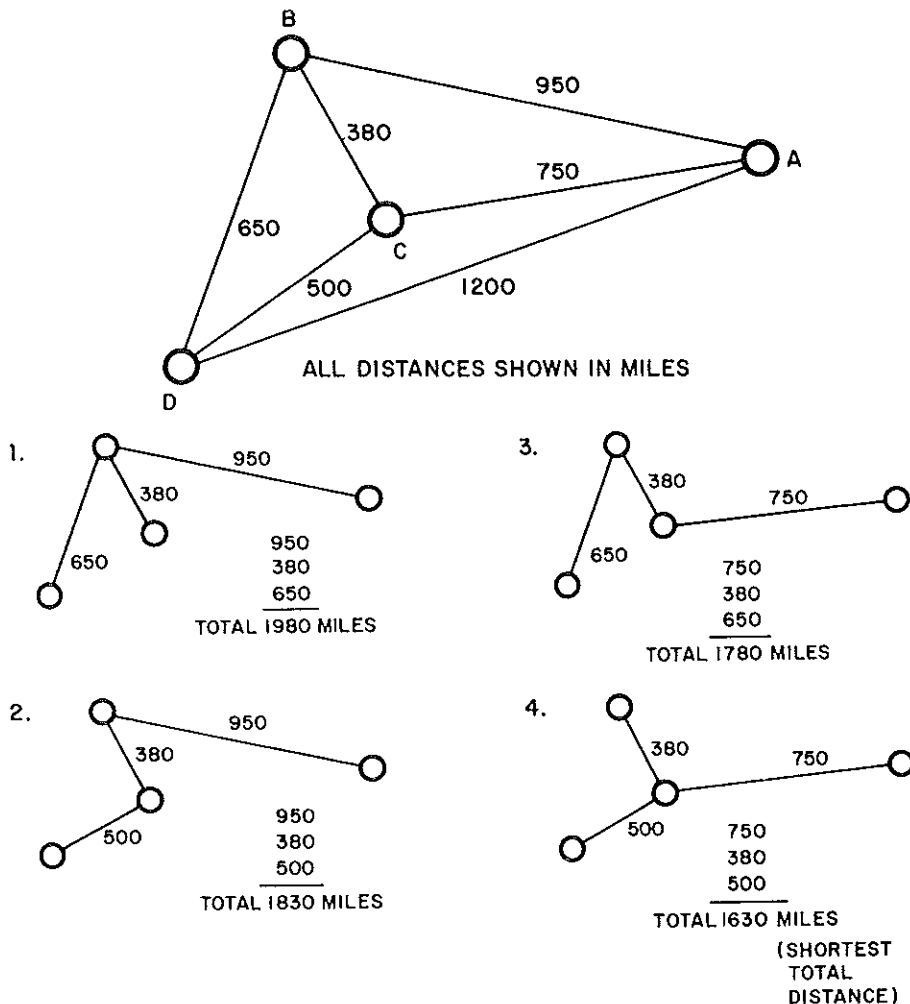

Figure 40. Multi-point IXC mileage determination

In the following sections, the common carrier offerings are described separately as exchange or private line, in the general speed groupings.

LOW SPEED SERVICE

This classification includes those facilities originally developed for use with teletypewriters and other channels ranging up to 300 bps. Reference is also included to higher grade facilities that are used at speeds of 300 bps or less.

Teletypewriter Exchange Service

TWX is the U.S. and Canadian exchange teletypewriter service offered in the U.S. by the Bell System and other telephone companies. Like the familiar telephone service, each subscriber has an individual line which is assigned a TWX number and is listed in a nationwide directory. Each station is equipped with a dial and numbers are dialed in the conventional telephone manner. The basic terminal provided is a teletypewriter with keyboard and printer. Paper tape equipment is optional.

At present, business machines can attach to TWX to communicate with teletypewriter stations. Through the use of data sets the business machine can be made to appear as a teletypewriter station or vice versa. When business machines communicate with business machines the service is referred to as TWX Prime. TWX Prime Service is described in the next section.

The original TWX network was separately constructed and maintained. All signals were either unipolar or bipolar direct current (DC) pulses. As the service grew, the demands on the network increased and it became necessary to provide additional facilities. Carrier telegraph systems were developed which adequately filled most growth requirements. As mentioned earlier, these systems derived as many as 18 telegraph grade channels from one voice-grade facility. Frequency division was used to derive the channels with each one assigned a different 180 cycle wide slot in the voice channel band. The carrier telegraph terminal ordinarily was located in the central office and the teleprinter operated on a DC basis between there and the customer's location. At the central office, the DC signals were frequency shifted to bursts of tone - each tone being within the limits of the channel's distinct 180 cycle band.

At one time, all TWX connections were made on a manual basis by operators at central switchboards. In 1963, all TWX stations were equipped with dials and permitted to dial their own connections. At the same time, the TWX network as a dedicated or separate entity was dissolved and all TWX stations

began using the same exchange voice facilities used by telephone subscribers. Under this arrangement, DC signalling would not work over the voice oriented telephone network and a device called a MODEM (Modulator-Demodulator) was required at each teletypewriter to frequency-shift modulate the data signals at their source.

The MODEM serves the same purpose as the carrier telegraph terminal but instead of being at the central office, it is built into the TWX station. Most TWX stations operate on conventional telephone lines and have a MODEM built into their housing to condition DC signals for transmission.

From its introduction TWX has been a 60 WPM (45.45 bps) service using baudot coded terminals. It is now also available at 100 WPM (110 bps) with the data interchange code. Even though 60 and 100 wpm TWX stations use different coding and operate at different speeds, they are able to communicate with each other because of speed and code converters built into the TWX network.

The overall cost of TWX is the sum of three factors: The cost of the subscriber loop and the monthly rental for the basic terminal or station equipment used on the line. There is a message or circuit usage charge based on the distance between the two stations, and the duration of the call. Circuit charges are the same for both 60 and 100 speed TWX service. With TWX as with telephone service, there is a 3-minute minimum period charge.

TWX 100 word per minute stations are equipped for unattended operation (optional on 60 word per minute). The unattended feature permits the machine to turn itself on, print the incoming message, and then turn itself off automatically without an operator. 60 word per minute stations are given a TWX number which has the same area code as telephones in that locale. However, 100 word per minute stations have one of four distinct area codes reserved for their exclusive use. This difference facilitates the communication between the two services.

TWX CE (TWX - Prime)

The customer provided terminal on the TWX station is capable of handling a transmission rate of up to 150 bits per second when a business machine calls a business machine. The common carrier will provide a special TWX line to be used with the customer terminal, and such an arrangement is popularly referred to as TWX prime (TWX'). TWX' operates the same as TWX with the exception that TWX stations and TWX'stations are prevented

from interconnecting without the extra cost arrangements shown in Figure 41. Businesses can transmit data in any form or code at up to 150 bits per second on an exchange basis in half or full duplex mode and the circuit charges are at the same TWX toll rates (see Table 2).

As previously described, all TWX stations have a MODEM which, on a frequency shift basis, changes the data signal to a series or sequence of tones. With TWX' stations, a MODEM is altered to operate with its frequencies inverted (I) to make TWX' stations incompatible with regular (N) TWX stations. Figure 41 shows several ways of connecting to TWX and TWX'.

TABLE 2

TWX - CIRCUIT USAGE CHARGES
(INTERSTATE)

MILES	FIRST MINUTE
0 - 50	.20
51 - 110	.25
111 - 185	.30
186 - 280	.35
281 - 450	.40
451 - 800	.45
801 - 1300	.50
1301 - 2000	.55
2001 & up	.60

Notes: All rates are approximate and intended for information only. Rates do not include Federal Tax.

Telex

TELEX is a world-wide exchange teleprinter service offered domestically by Western Union and operates with baudot code at 66 words per minute. The method of operation is similar to that of TWX. Teleprinter is the Western Union equivalent term for the Bell System and the telephone companies teletypewriter.

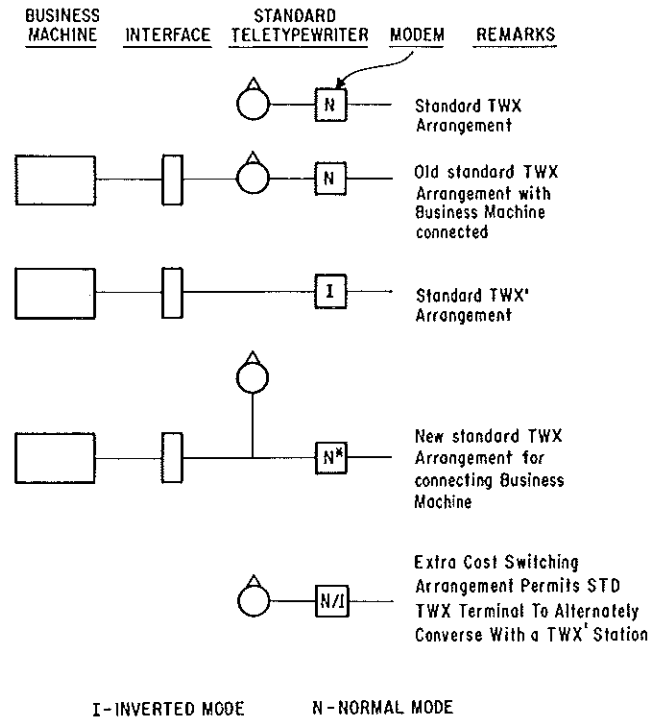

* THIS MODEM INCLUDES A BI DIRECTIONAL SERIALIZER-DESERIALIZER.

Figure 41. TWX & TWX' station arrangements

Each station is equipped so the calling party or station can dial the called station's number. No more than 7 digits are required to reach any TELEX customer. There also are fewer intermediate switching points, which make connection times faster than those of TWX.

The biggest difference between TELEX and TWX is the method of charging for use of the service. Although the cost for both services is based on time and distance, there is no minimum TELEX period. Depending upon distance, each call is assigned a specific pulse rate. This rate is expressed as pulses per minute (PPM) and billing is based on the number of pulses used per month. On an 18 PPM call, if the connection lasted for only 1/2 minute, the customer would be charged for 9 pulses. Table 3 shows the pulse rates and equivalent cost for one minute calls of any distance. The monthly service charge includes both the line and station equipment charges.

With TELEX, all stations are equipped for unattended operation.

The TELEX billing arrangement offers several advantages - especially if messages are very short. In addition to paying only for what time he uses, the customer with heavy volumes (over 15 to 20 minutes/day) can take advantage of a discounted rate which applies to all pulses over 3500 in a billing month. Business Machines connect through TELEX Interface units and can originate and answer calls without human intervention.

TELEX stations can interconnect directly with TELEX stations anywhere in the world without speed or code conversion. There are about 100,000 such terminals at present.

TEL(T)TEX is a service whereby a TELEX subscriber can send regular telegrams to any non-TELEX subscriber in certain TEL(T)TEX equipped cities. It gives the customers station equipment a dual use and enables the subscriber to send his own telegrams at rates that are sometimes lower than regular telegram rates. However, not all TELEX cities are TEL(T)TEX cities.

High Speed Offerings Operating at Low Speed

The telephone companies, through use of a unique data set, provide a full duplex (FDX) data mode on

the regular public exchange telephone system at up to 300 bps. The operation and rates remain the same.

Western Union has a relatively low speed schedule in Broadband and Exchange Service for up to 600 bps in FDX mode. The operation is the same as in higher speed schedules except there is no alternate voice capability. The schedule also has a special set of rates.

Private Line Services

Teletypewriter Grade (dc)

Both the telephone companies and Western Union offer this as both a service (with dc teletypewriters) and a channel (lines only). Because the dc teletypewriter machines operate at three discrete speeds, the carriers offer the service at these three speeds and the channels are offered at three equivalent maximum bit rates. These are 60, 75 and 100 wpm, and 45, 55 and 75 bps. The lease rates for these facilities are the same whether obtained as a service or as a channel, and from either carrier. They consist of three parts, as previously explained: an interexchange (or intercity) channel, channel terminal, and local channel.

The basic rate is for the 60 and 75 wpm services, which have been combined. The 100 wpm service

TABLE 3

TELEX CIRCUIT USAGE CHARGES

Miles	Pulse Rate Pulses Per Minute (PPM)	Equivalent Rate Per Minute**	
		First 3500 Pulses	All Pulses Over 3500
The U.S. is now divided into 12 rate areas and pulse rate applies from rate area to rate area - no longer dependent on mileage.	5	12.5¢	7.5¢
	7	17.5	10.5
	9	22.5	13.5
	12	30.0	18.0
	15	37.5	22.5
	18	45.0	27.0
	21	52.5	31.5
24	60.0	36.0	

Rates do not include Federal Taxes.

**First 3500 pulses in any month are billed at 2.5¢ per pulse.

All pulses over 3500 in any month are billed at 1.5¢ per pulse.

is generally 10% above the basic rate. Table 4 shows these rates in detail.

Teletypewriter service and channels are available only on a full time basis to most customers. There is another tariff offering, using an entirely different price structure, which offers part time channels and service to press customers. This special offering is beyond the scope of this book.

When this facility is obtained as a service (with teletypewriters), both common carriers provide varieties of control systems to use with them. In general, these systems are based on the transmission of sequences of characters to indicate such events as: Start of Message, Address, Answer-back, End of Address, End of Message, etc. These systems are discussed in following sections.

TABLE 4
INTERSTATE PRIVATE LINE TELETYPEWRITER
GRADE CHANNELS

(Each link between two channel terminals is priced separately for mileage)

MONTHLY COST

AT&T Nomenclature Western Union Nomenclature	Type 1002 Schedule 1 or 2 Class A&B	Type 1005 Schedule 3 Class C
HALF DUPLEX SERVICE		
a) Interexchange Channel Rate Per Mile For:		
First 250 miles (0-250)	\$1.10	\$1.21
Next 250 miles (251-500)	.55	.605
Next 500 miles (501-1000)	.44	.484
Next 500 miles (1001-1500)	.385	.424
Thereafter (1501 & over)	.385	.424
b) Channel Terminal	12.50	13.75
c) Local Channel (Loop)	6.70	7.37
FULL DUPLEX SERVICE		
a) Interexchange Channel Rate Per Mile for:		
First 250 miles (0-250)	\$1.21	\$1.331
Next 250 miles (251-500)	.605	.666
Next 500 miles (501-1000)	.484	.532
Next 500 miles (1001-1500)	.424	.466
Thereafter (1501 & over)	.424	.466
b) Channel Terminal	13.75	15.13
c) Local Channel (Loop)	13.40	14.74

Subvoice

Both Western Union and the telephone companies offer this facility as both a service (with teletype-writers) and a channel (lines only). As a service the facility operates within the speed limitation of the teletypewriter although the facility has a speed limitation of either 150 bps or 180 bps. The lease rates for these facilities are the same whether obtained as a service or as a channel, and from either carrier. They consist of three parts as previously explained: An interexchange (or intercity) channel, channel terminal, and local channel. In addition, a station arrangement is required on each local channel. Table 5 shows these rates in detail.

VOICE GRADE SERVICES

This classification includes those facilities originally developed for use with telephone handsets, and today identifies a channel having a usable bandwidth of about 3000 cycles per second.

Public Exchange

Telephone System

This facility is offered by the telephone companies and provides the basic residential and business tele-phones with which we are familiar. Connections can be established to almost any telephone in the world.

TABLE 5
INTERSTATE PRIVATE LINE SUBVOICE GRADE CHANNELS

(Each link between two channel terminals is priced separately for mileage)

AT&T - Type 1006, Private Line Service maximum speed 150 bps
WU - Class D, Service maximum speed 180 bps

MONTHLY COST

	HDX	FDX
Interexchange Channel		
First 250 miles	\$1. 375	\$1. 513
Next 250 miles	. 688	. 757
Next 500 miles	. 550	. 605
Over 1001	. 481	. 529
Each Channel Terminal	15. 63	17. 19
Each Local Channel	8. 38	16. 75
Each Station Arrangement:		
AT&T Channels		\$25. 00
WU send & receive stations		13. 75
WU send only stations		13. 75
WU receive only with WU machine		5. 25
WU receive only with business machines		6. 25
For AT&T Channels, specify one type of regenerator for each line:		
ASC II Type	11. 0 bits/char. , 110 bps	
BCD Type	9. 0 bits/char. , 134. 49 bps	
Baudot Type	7. 42 bits/char. , 74. 2 bps	

Every access to the telephone system is now a subscriber loop and there must be a telephone on that loop. All equipment directly attached to the loop (including data sets) must be provided by the common carrier. Because each telephone company provides this equipment, these rates are filed in intrastate tariffs rather than with the FCC.

For data use of this facility, the telephone companies provide several data sets. Most telephone companies also require that data sets can only be attached to single party business lines.

Monthly charges (other than equipment), include a service charge (intrastate tariffs) based on the number of telephones that can be called toll-free and charges for each call to all other phones based on distance, length of call (with a 3 minute minimum), and time of day and day of week.

The toll rates for interstate calls are shown in Table 6. Distances under 25 miles are subject to greater minimum times and range from 10 to 25 cents.

The United States and Canada have been divided into Numbering Plan Areas (now called Area Codes), as shown on the map in Figure 42. Each telephone line within an area has a 3 digit exchange number (may be alphameric) and a 4 digit line number. The resulting 10 digit number is therefore unique within the United States and Canada and permits direct distance dialing (DDD) between dial equipped telephones.

These facilities can be specially arranged for customers in several ways:

PBX - A customer may have an interior telephone system in which certain (or all) interior telephones can be connected with the outside telephone system via a customer operator. Two varieties of this permit direct outward placing of calls, and direct inward calling (Centrex). The PBX system allows several customer locations to be interconnected into

a decentralized interior system using the lines as in Figure 43. When such a system is completely dial operated, without operator intervention, it usually becomes a Common Control Switching Arrangement (CCSA) with many optional features beyond the scope of this book. Decentralized interior systems originally designed for voice may have to be upgraded before satisfactory data transmission can be accomplished.

Foreign Exchange (FX) - A foreign exchange line is a combination of both exchange and private line services. It is a telephone connected to an exchange but located outside (foreign) of the geographical area served by exchange. Figure 44 is an example of a Philadelphia customer with a St. Louis FX line. The local exchange designation in Philadelphia is RI 3 and in St. Louis is SL 7. As seen by the sketch, the St. Louis telephone line SL7-1200 is in effect "stretched" to appear in Philadelphia. It is a St. Louis number served from St. Louis but its telephone is in Philadelphia. When Philadelphia picks up the telephone, the dial tone comes from St. Louis and with this line, all calls from Philadelphia to St. Louis are on a local charge basis. Conversely, all calls from St. Louis to Philadelphia on that particular line also are billed as local calls. The Philadelphia customer pays for the St. Louis business line plus the cost of the private voice grade line between the two cities.

DATA-PHONE - When data transmission over the telephone system is desired, the telephone company supplies a data set and Bell System companies call such an arrangement DATA-PHONE.

TABLE 6

STATION TO STATION TELEPHONE TOLL RATES

(within Continental U. S. A.)

RATE TABLE - TWO-POINT SERVICE, PAID AND COLLECT RATES									
Rate Airline Miles		Day			Evening and Saturday 6-8 PM			Night and Sunday 8 PM to 4:30 AM	
Over	Up to and Including	Init. 3 Min.		Each Addi- tional Minute	Init. 3 Min.		Each Addi- tional Minute	Init. 3 Min.	Each Addi- tional Minute
		Station to Station			Station to Station			Station to Station	
24	30	\$.30		\$.10	\$.30		\$.10	\$.30	\$.10
30	40	.35		.10	.35		.10	.35	.10
40	55	.40		.10	.40		.10	.40	.10
55	70	.45		.15	.40		.10	.40	.10
70	85	.50		.15	.40		.10	.40	.10
85	100	.55		.15	.40		.10	.40	.10
100	124	.60		.15	.45		.15	.45	.15
124	148	.65		.20	.50		.15	.50	.15
148	172	.70		.20	.55		.15	.55	.15
172	196	.75		.20	.55		.15	.55	.15
196	220	.80		.20	.60		.15	.60	.15
220	244	.85		.25	.65		.20	.60	.15
244	268	.90		.25	.70		.20	.60	.15
268	292	.95		.25	.70		.20	.60	.15
292	316	1.00		.25	.75		.20	.60	.15
316	354	1.05		.30	.80		.20	.60	.15
354	392	1.10		.30	.85		.25	.65	.20
392	430	1.15		.30	.85		.25	.65	.20
430	468	1.20		.30	.85		.25	.65	.20
468	506	1.25		.30	.90		.25	.65	.20
506	544	1.30		.35	.90		.25	.65	.20
544	675	1.35		.35	.95		.25	.65	.20
675	800	1.40		.35	1.00		.25	.70	.20
800	925	1.45		.40	1.05		.30	.75	.20
925	1050	1.50		.40	1.05		.30	.75	.20
1050	1175	1.55		.40	1.10		.30	.80	.20
1175	1360	1.60		.40	1.15		.30	.80	.20
1360	1605	1.70		.45	1.20		.30	.90	.25
1605	1910	1.80		.45	1.30		.35	.90	.25
1910	2300	1.90		.50	1.40		.35	1.00	.25
2300		2.00		.50	1.50		.40	1.00	.25

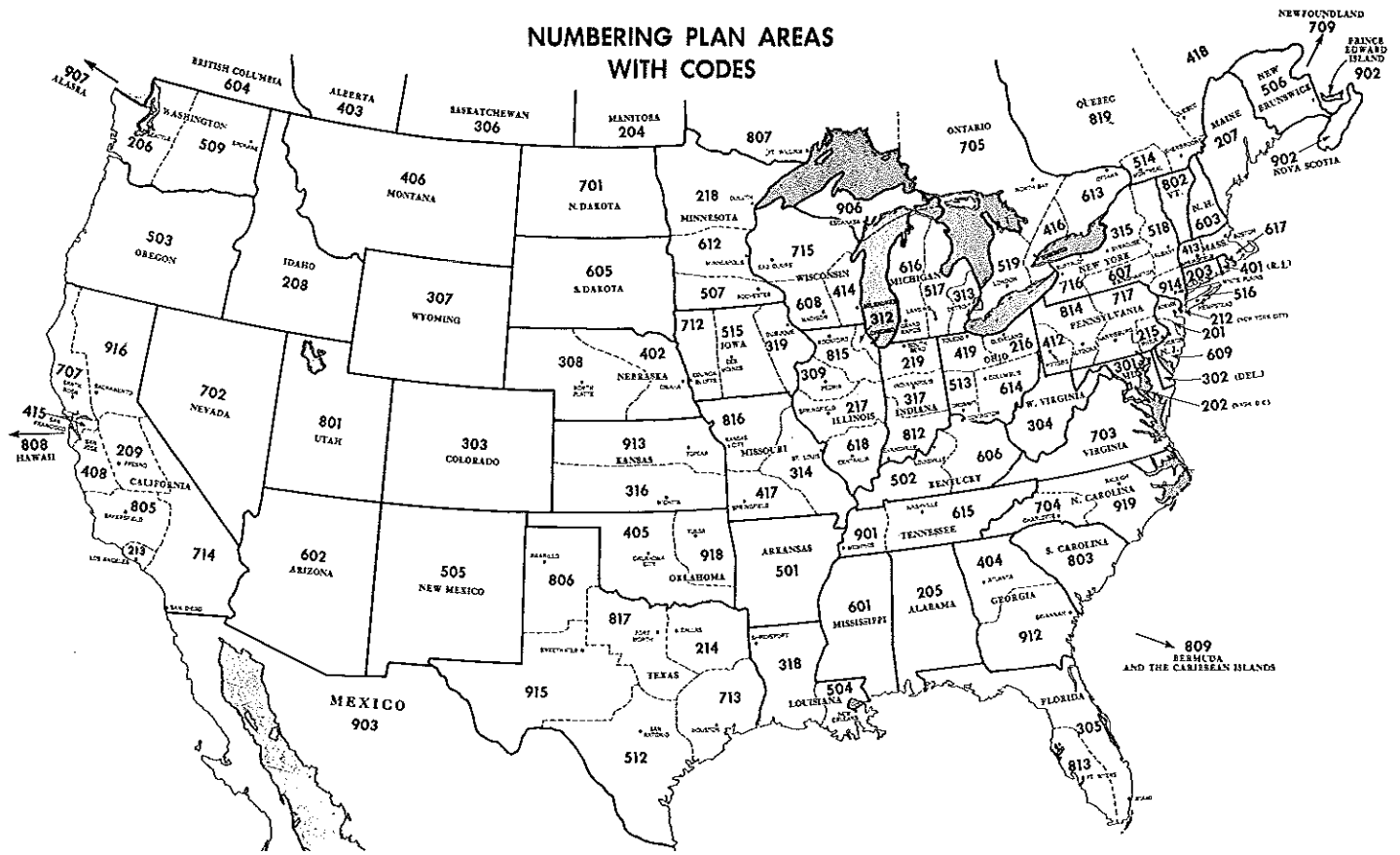

Figure 42. Numbering plan areas with codes

In addition to the mod-demod function of a data set, these also can automatically answer telephone calls in the data modes. Currently there are data sets available to operate, over a conventional telephone connection at serial speeds of: 300 bps max FDX, up to 1200 bps max HDX, and 2000 bps fixed HDX. In addition two parallel speeds of 20 char/sec maximum HDX and 75 char/sec maximum HDX are available, as well as special

analog units. A description of data set functions and examples is found in the Appendix.

Automatic Calling Unit - To further automate data transmissions when computers are involved, an Automatic Calling Unit is available which can accept information from a business machine, place a telephone call, and turn over the circuit to an associated data set.

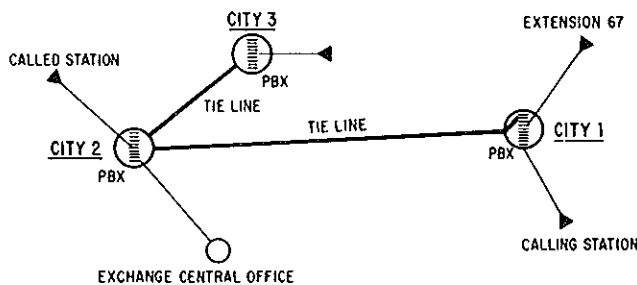

Figure 43. Tie line operation

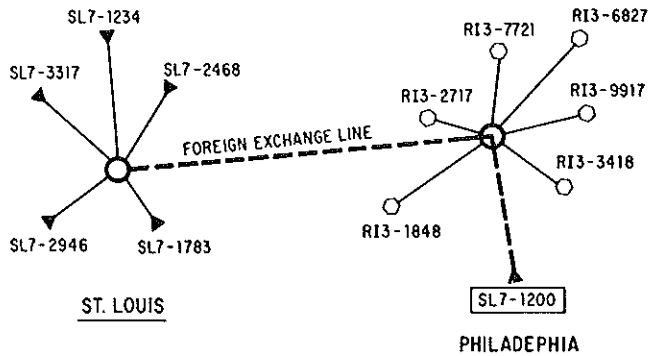

Figure 44. Foreign exchange service

Wide Area Telephone Service (WATS)

This facility is a special arrangement of both the access to the telephone system and the charges for using it. WATS is offered on an interstate basis by AT&T and nearly all other domestic United States telephone companies. It is offered, separately, on an intrastate basis in almost every state by the Bell System companies and nearly all other connecting companies.

A WATS access line is permitted to place as many calls as desired, lasting as long as desired, to all the telephones in a specified geographical zone for either a fixed hourly rate (monthly minimum 15 hours free) or a flat monthly charge.

For interstate WATS, each state (or position of larger ones) considers the other 47 states assigned to one of six zones, where zone 1 is a band of nearby states, and zone 6 is a band of furthest away state as in Figure 45. Service to a specific zone includes service to all nearer zones so that zone 6 always includes all the contiguous 47 other states. Interstate WATS always excludes service to the entire "home" state. Any calls placed on the access line to locations not covered by the specified zones are charged at regular toll rates (or such calls can be intercepted, optionally).

The bands or zones have been designed on the basis of quantity of accessible phones as well as the

distance to them. Therefore, the geographical sizes differ depending on home state. In addition to simplify the system, arbitrary boundaries were chosen to be state lines or area code boundaries for partial states. The inequities this caused are balanced by slightly differing rates depending on home state.

WATS is a one-way originating service, requiring the subscriber to originate all calls. Once the call is established, however, the facility is the same as regular telephone service. Person-to-Person, Collect, Conference, Credit, and third party calls are all prohibited. The same data sets as listed under telephone system are used for WATS.

Intrastate WATS is the same as interstate except for definition of area served. A few states offer partial state coverage.

Inward WATS is presently being offered in some states. This service allows incoming calls from the prescribed area to be charged at a flat rate by the subscriber.

Broadband Exchange Service (BEX)

This facility is offered by Western Union in and among certain cities in the United States. Dialed connections provide 4 wire FDX channels designed for data with alternate voice capability. In addition to 4-wire FDX capabilities two unique rate factors

INTERSTATE CALLING AREAS
KENTUCKY

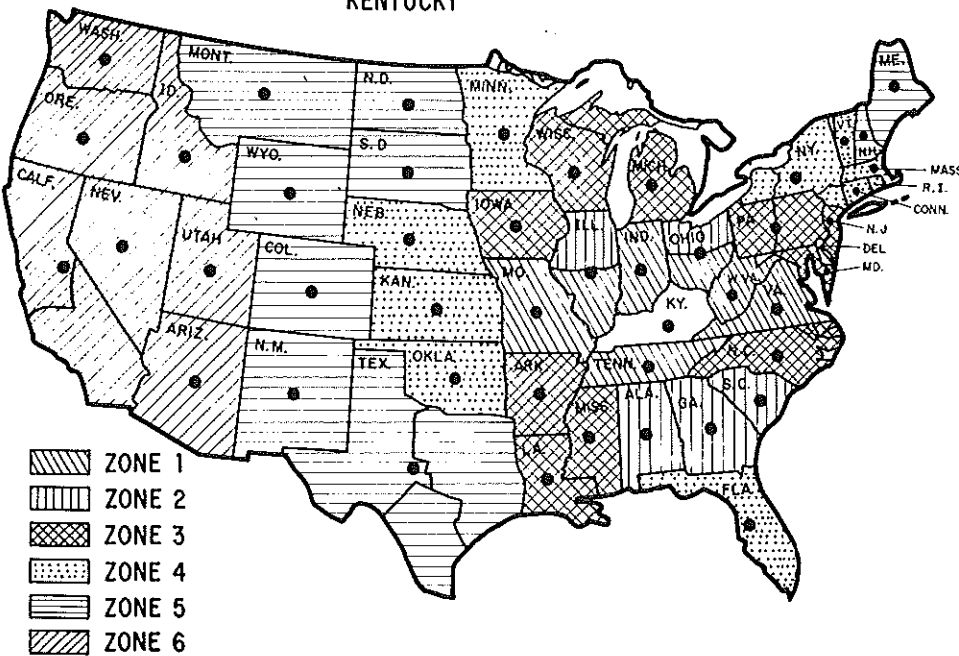

Figure 45. Sample wats map

are the ability to specify (in the dialed number) the bandwidth desired, and a 40% discount on the tolls over a fixed amount per month. Otherwise the facility is a straight toll call system with a one minute minimum. Bandwidths presently available are 2kc and 4kc, while 48kc is planned for future offering.

For data transmission with computers, an automatic calling device is available, as well as automatic answering data sets.

Private Line

There is only one private line facility offered by the common carrier in the voice grade category. A voice grade channel similar in characteristics to the channel obtained by dialing a connection in the telephone system. For data use, special conditioning equipment can permit greater speeds and/or less susceptibility to errors. Conditioned lines are described separately below.

Voice Grade Channel

A voice grade (telephone) leased line was originally offered by the telephone companies to be used in interior telephone systems as tie lines or trunks. These lines are now offered by common carriers for voice, or data, or alternate use.

For data or alternate data/voice use, the data set may be provided by the common carrier or the customer. Although the carriers do not guarantee any particular performance on these lines (other than ability to transmit a voice signal), experience shows they can average better than a long toll call due to reduced switching noise and variable cross talk.

Western Union calls these lines Class G, and the telephone companies call them Schedule 4-Type 3002, when used for data or alternate. Data sets from common carriers are available for the following speeds: 300 bps maximum, 600 bps maximum, 1000 bps maximum, 1200 bps maximum, 2000 bps fixed; 20 char/sec maximum, and 75 char/sec maximum.

Higher speeds are shown in the next section on conditioned lines. Rates for ordinary voice grade lines are shown in Table 7. Half Duplex rates also permit full duplex data, if possible on a two wire circuit. Full Duplex rates are charged when full duplex data or a 4 wire circuit are required.

Conditioned Voice Grade Channels

Both common carriers offer certain levels of guaranteed specification limits, at extra cost per terminal per month. These specification limits refer to:

Attenuation and frequency response, delay, and noise. Each more expensive level imposes tighter limits, permitting greater data speeds (less distortion) and/or better error performance (less noise and distortion). No equivalence between these advantages and the specific levels has been developed, however. Trial and error at installation is preferred by the carriers. IBM has specified a certain level for some of its teleprocessing equipment. The level names and equivalence between carriers is shown in Table 7.

Common carrier data sets for conditioned lines the same as for ordinary lines, with the exception that greater speeds are available. The 1000 bps maximum is good to 1800 bps maximum, and a 2400 bps fixed and maximum is available. Commercial development of higher speed data sets by many non-carriers has concentrated on the use of conditioned voice grade lines. Speeds in the area of 4800 bps are presently possible with announced equipment.

BROADBAND SERVICES

These are facilities which physically use a channel of greater frequency bandwidth than a voice grade channel.

Public Exchange

No facility is presently offered, but Western Union's Broadband Exchange (explained under Voice Grade) is planned for 48kc operation.

Private Line

Both Western Union and the Bell System offer this facility as TELPAK Broadband channels in the following bandwidths:

- A - 48,000 cps
- C - 240,000 cps
- D - 1,000,000 cps

These channels are Full Duplex and can be obtained arranged for digital data, for analog signaling or subdivided into lower speed channels. The subdivided mode is described in the section on Groups of Channels.

Mileage rates for TELPAK channels are structured much differently than lower grade lines. Each mile costs the same regardless of the length of the link.

The common carrier always provides termination equipment for these channels. Called a channel terminal, this includes the cost of a data set, voice coordinating channel, and local channel. A channel terminal charge is incurred for every terminal connected to the channel. There is no provision for extensions.

GROUPS OF CHANNELS

Common carriers provide arrangements for groups of private line channels that terminate in the same two locations. Called TELPAK, it is related to

the broad band offering of the same name, but only because of the way the tariff was written.

The basic building block of TELPAK groups is 12 equivalent voice channels. Any lower grade private line channels may be grouped (but not mixed) into one equivalent voice channel as follows:

Up to 12 Telegraph channels HDX or FDX per equivalent voice channel.

Up to 6 class D channels HDX or FDX per equivalent voice channel.

Up to 4 Schedule 3 A channels HDX or FDX per equivalent voice channel.

TABLE 7
VOICE GRADE INTERSTATE DATA CHANNELS
 Type 3002
 AT&T - Schedule 4, Type 4
 Wester Union - Class G

Airline Miles	\$ Per Month	
	Half Duplex	Full Duplex
0-250	\$ 2.02	\$ 2.222
Next 250	1.717	1.888
All over 500	1.616	1.777
Channels		
Terminals	\$ 12.50	\$ 13.75
Local Channel	12.50	17.50
Telephone Cos.	10.00	18.25
Western Union		
Key for alternate data	\$15.00	

CHANNEL CONDITION CHARGES

Western Union Name	Class G	Class E	Class F	Not Offered
Telephone Company N.	Type 4 3002	Type 4A 3003	Type 4B 3004	Type 4C 3005
Point to Point				
Each Station	-	\$ 10.00	\$ 37.50	\$ 56.00
Multi Point				
First station in an Exchange	-	20.00	47.50*	Not Offered
Add'l Station in an Exchange	-	6.00	20.00*	20.00

Note: Channel conditioning charges for duplex are same as for half duplex.

Broadband channels TELPAK A and C can also be obtained as equivalent voice channels as follows:

Each TELPAK A broadband equals 12 equivalent voice channels.

Each TELPAK C broadband equals 60 equivalent voice channels.

Figure 46 shows a typical, two section Telpak group, and how the equivalent channels were determined.

Some features and restrictions of Telpak groups are:

Each subchannel maintains the same characteristics and rules as when obtained separately. This includes who provides data set, type of signalling, etc.

The various subchannels in a group need not be physically part of a broadband channel.

Indeed, they can exist in separate cables and follow different land routes.

At extra cost, groups of equivalent channels can be switched from group use to single broadband use at control of customer.

Customers in the same business who are regulated by the government may lump their requirements in order to take advantage of these rates.

Each subchannel is Full Duplex and can be terminated as Half Duplex if desired.

Channel terminals for channels of voice grade or lower grade provide just the functions of channel terminal and local channel in single private lines. Data sets, where needed, are available and priced as on single private lines.

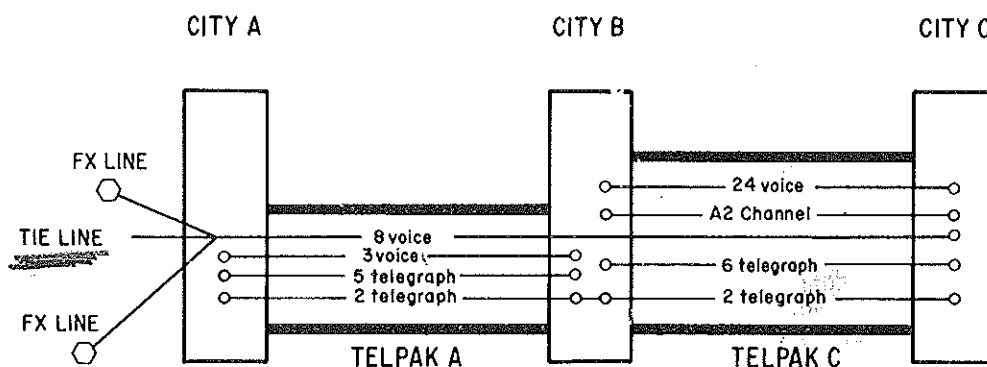

	<u>Sales Office</u>	<u>Plant</u>	<u>Headquarters</u>
Channel Terminals	11 voice 5 telegraph	27 voice 11 telegraph 1 DATA	32 voice 8 telegraph 1 DATA
Equivalent Voice Channels	$8 + 3 + 1 = 12$	$24 + 12 + 8 + 1 = 45$	

Figure 46. Various telpak arrangements

TABLE 8

TELEGRAPH LINE CONTROL SEQUENCES

Signal Type	AT&T 83B2 HDX	WU 115 HDX	AT&T FINAC FDX	WU 117 FDX	AT&T 81D1 FDX	WU 57 FDX	WU 111 Conten.
Station Request to Send	①	①	①	①	①	Space or ①	3.0 Sec Open
Polling Sequence Initial (from central)	EOM	EOM	③	FIGS Z	Blank .4 Sec Pause Space	Y	②
Transmitter Start Code (from central)	ALPHA MorG	X ALPHA	CR ③ ALPHA	ALPHA	ALPHA	ALPHA	②
Positive Response (from station)	Msg	Msg	Msg	Msg	Msg	Y	②
Negative Response (from station)	V or 2 Sec	V or 10 Sec	1.0 Sec	V or 2 Sec	H or 5 Sec	Space	②
End of Polling (from central)			③	④	2 LTRS .2 Sec Pause	CR	②
Selection Sequence Initial SOM (from sender)	LTRS LTRS LTRS	LTRS LTRS LTRS	LTRS LTRS LTRS	FIGS H LTRS ⑦	FIGS H LTRS (optional)	W	LTRS
Selection Code (from sender)	ALPHA ALPHA LTRS	ALPHA ALPHA	(ALPHA) (option) ALPHA LTRS	Q ⑥ 3 LTRS 2 ALPH	ALPHA ALPHA LTRS	ALPHA ALPHA ⑤	ALPHA
Positive Response (from addressee)	V	V	None	V ⑥	None	ALPHA (complement of Selection)	None
Negative Response (from addressee)	10 Sec	?	None	? ⑥	None	?	None
End of Selection (from sender)	CR LF	Space CR LF	CR	Space	CR LF LTRS	Space Space	CR LF Space LTRS
EOM	FIGS H LTRS	FIGS H LTRS	FIGS H LTRS	FIGS H LTRS	FIGS H LTRS	FIGS H LTRS	Not Fixed
EOT					EOM + H LTRS		

GENERAL NOTES TO TABLE 8

Polling Sequences normally include several TSC codes, each followed by a response, except as noted.

The term ALPHA refers to any alphabetic character from the specific list for the particular system.

IN HDX systems, a message must start with a selection sequence, even if no selections are included.

In FDX systems, a message from a station can only be sent to a central or control station. Messages to stations are only sent from the central or control station.

SPECIFIC NOTES TO TABLE 8

- ① Station Request recognized only as the result of a poll.
- ② This is a contention system - each station controls its own entry to the line using a Way Station Selector 7304.
- ③ A TSC is sent following every CR in the text. If there is traffic on the incoming line (no poll required), a BLANK is sent instead of the ALPHA. Terminals on this system automatically initiate a CR and LF when they receive a CR.
- ④ The TSC code unblinds all previously selected printers for continuing outgoing traffic; thus, each TSC must be preceded by FIGS Z, but no end-of-polling code is needed.
- ⑤ Each WU57 Selection Code is always one alphabetic character repeated once.
- ⑥ Response to Selection is optional; a Q and three LTRS preceding the Selection Code will trigger the answer. Only the last Selection on each message can be required to answer back, and only one of a group code.
- ⑦ Must precede the first message in each transmission.

TABLE 9
TERMINAL CONTROL SEQUENCES

	1050	1060	1070	1030
Polling Sequence Initial (from central)	(C)	(C)	(C)	(C)
Transmitter Start Code (from central)	ALPHA plus Component Selection Number	A plus Component Selection Number	ALPHA ₁ 0 or 2	ALPHA
Positive Response (from station)	(D) TEXT	(D) DATA	(D) TEXT ALPHA ₁	(D) DATA
Negative Response (from station)	(N)	(N)	(N)	(N)
End of Polling (from central)	(C)	None	None	None
Addressing Sequence Initial (from central)	(C)	(C)	(C) (S)	(C) (S)
Selection Code (from central)	ALPHA plus Component Selection	A plus Component Number	ALPHA 9	ALPHA 1
Positive Response (from station)	(Y)	(Y)	(Y)	(Y)
Negative Response (from station)	(N)	(N)	--	(N)
Response to Positive Response (from central)	(D) TEXT	(D) TEXT	(D) Q 3 digit MTU address (T) TEXT	(D) TEXT
EOB	(B)	(B)	(B)	(B)
Positive Response to EOB - LRC	(y)	(y)	(y)	(y)
Negative Response to EOB - LRC	(n)	(n)	(n)	(n)
EOT	(C)	None	(C)	(C)

SWITCHING CONCEPTS

In data communications the word switching denotes the routing of the intelligence that is to be transmitted. There are two types of switching, one that switches or changes the circuits involved to conform to the desired route or the intelligence is routed over different circuits to reach its destination. The telephone network is the best example of circuit switching and because it is the most common a good explanation of the network will give a basic understanding of the switching concepts.

TELEPHONE SWITCHING OR CIRCUIT SWITCHING

Circuit or line switching does not require the receipt and retransmittal of messages. A communication center provides a connection between the terminals. The telephone system as described here is an example of circuit switching for voice communication.

The early subscribers to telephone service had their telephone connected by separate wires to each of the other subscribers in their particular area. It was not permissible for them to converse with subscribers similarly connected in a remote town or city.

Because each telephone was connected directly to all others, the network was called a non-switched network. (See Figure 47.) All stations have the ability to communicate at the same time and for this reason, the network is called a non-blocking network. It is obvious, as the number of telephones grew, the non-switched system became impractical.

The solution to expansion problems was to bring all subscriber lines to a central location where attendants could make the necessary wire connections between the calling and the called telephones. The process of manual interconnection is called manual switching and is performed by telephone operators.

The place where all lines are brought for switching is called a "central" office and this type network, illustrated by Figure 48 is called a switched network.

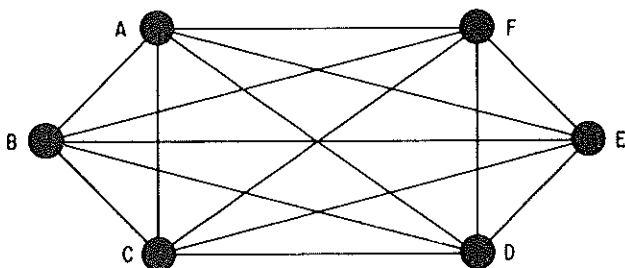

Figure 47. Non-switched network

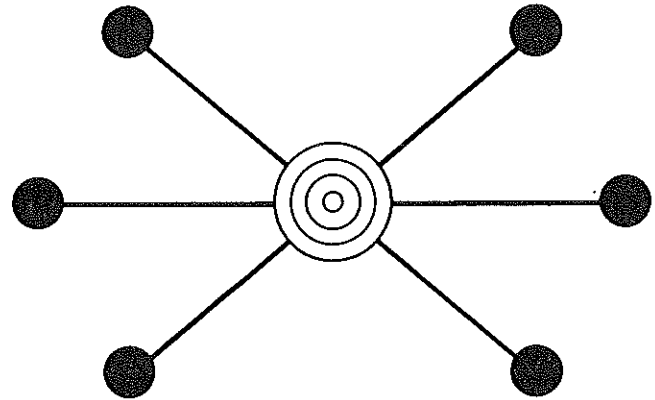

Figure 48. Switched network

All telephone calls handled at a central office either by operators or automatic equipment are called "exchange" calls. For this reason the telephone central office is often referred to as an exchange. Exchange calls between subscribers in the same central office are called intra-office calls. These descriptive terms were coined before the turn of the century and are still found in use today.

Central Offices resulted in economical interconnection of subscribers on an intra-office basis but did not permit calling subscribers served by other exchanges. These inter-office calls as the name implies were made by connecting central offices together by a network of channels. The wires connecting subscribers to a central office are called subscriber loops. Wires or circuits connecting central offices together are called trunks.

For basically the same reasons that each subscriber could not have direct lines to all other subscribers in a telephone network, central offices cannot have direct trunks to all other central offices. When the volume or number of calls (called traffic) between two central offices is large, it is routed over a direct trunk. Direct trunks are called high usage trunks. When the traffic between two offices is small, it usually is routed over a series of separate trunks assembled together by switching equipment at intermediate offices. Special intermediate offices used for switching toll facilities only are called Control Switching Points (CSP's) and their operation is shown in Figure 49.

In calling from central office A to B, there may be occasions when the traffic will exceed the call carrying capacity of the direct trunks between A and B. When this occurs, the switching equipment at A will automatically attempt to complete the call by the connection made at the CSP. The two trunks connected via this office comprise an alternate trunk route.

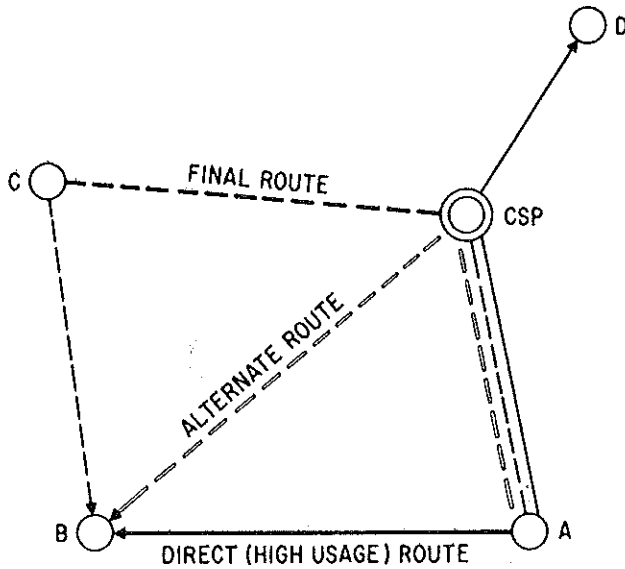

Figure 49. Trunk arrangements

Alternate routing is the ability to automatically select a second or third "best way" to complete a call when the best (direct) route is busy. Most central offices and all control switching points have the ability to provide automatic alternate routing. When all alternate routes (there usually are several) have been selected and found busy, the final attempt is made on a "final" trunk group. If this final group is found busy, the caller is notified by a busy signal.

Many times when a busy signal is heard while making a telephone call it possibly could be the result of trunks and not the called telephone being busy.

As special intermediate routing offices only, the CSP's ordinarily serve no telephones--just trunks from other central offices. Precise routing patterns have been established for central offices, trunk groups, and CSP's. This overall plan from which all routes are assigned is called the toll switching plan and is illustrated by Figure 50. In addition to specifying routing patterns, all central offices and CSP's are categorized into five classes by function and area served.

In completing a call, if the first choice (direct) route is found busy, the call will be automatically routed to the next higher step office in the switching chain. When calling from A to K (see Figure 50), the routing would be ABC and then 1 to 4 in that order. If after these attempts, the call still was uncompleted, it would follow the final route (5) (indicated by solid lines) up one side of the chain and down the other. Because of the provisions of the toll switching plan, it is possible to have eight intermediate switching points involved in completion of a call. When that many points are involved as many as 20 seconds or longer may be needed to complete a call after the last digit is dialed. Although this rarely happens this time takes on added importance when one considers some data messages are less than 30 seconds in length.

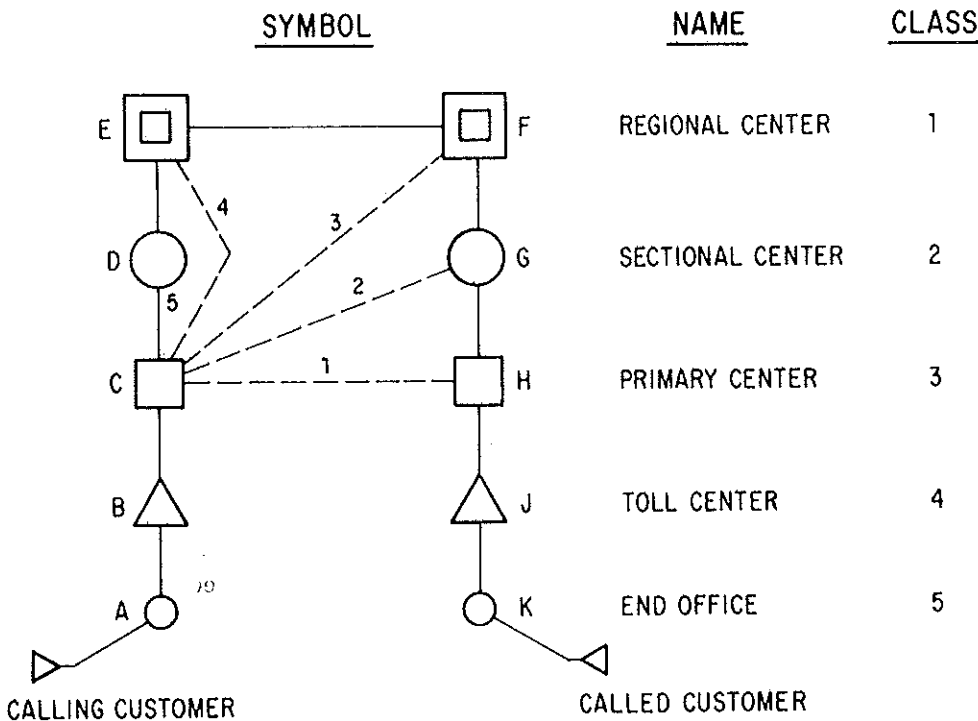

Figure 50. General toll switching plan

In addition to the switching or connection time, it also takes about 15 seconds to dial a call manually. With standard rotary dials, this time will vary with the value of the digit dialed. For example, several ones could be dialed in the same time it takes to dial a nine or zero. Push button dialers will permit dialing 10 digits in 5 to 8 seconds and automatic calling devices are capable of reducing this time to less than 2 seconds.

It would serve no purpose to delve more deeply into alternate routing and the toll switching plan. It is important that these things be remembered-- dialing and connection times may be as high as 30-40 seconds and data can't be transmitted while the call is being established; and set-up time must always be considered in designing data communication systems.

As we learned earlier, trunks in a group can be wire, carrier, coaxial, microwave or a combination of all these facilities. A person making numerous calls to a distant telephone may never use the same communication channel twice. As a result of alternate routing, even different trunk groups would probably be used. With private lines, there is no routing involved because the circuit is dedicated for the customer's exclusive use.

Intra-office calls are either manually or automatically switched. Manual central offices, for the most part, have been replaced by dial equipment but many businesses are still served by manual switchboards. Manual switchboards have some characteristics which can make them unsuitable for handling data communications. Each station appears as a hole (called a jack) in multiple appearances on a switchboard. To complete a call, the operator simply plugs a cord into the called station jack. Before actually plugging in the connection, however, the operator ordinarily tests for a busy condition by short circuiting the station jack with the cord. Ordinarily, if you were talking when this occurred, you would hear a crackle on the line which would be irritating but of minor consequence, however, this interruption could cause a considerable number of information bits to be lost. Should the cord be pulled down permanently, it would disconnect the call before it was completed. For these reasons, manual switchboards are not generally suitable for data transmission.

Automatic switching equipment has been used on a large scale for over forty years. The older type equipment is generally more subject to the introduction of errors in data communications than is newer equipment. The reason for this is older switching equipment (panel and step-by-step) is characterized by sliding contact switches. Improper adjustment or dirt could cause noise, interruptions or complete disconnects. Even activity in adjacent equipment may cause these problems.

Modern switching equipment uses crosspoint connections rather than sliding contacts. It also has more parallel switch contacts per connection than older equipment. Because of these two factors, it is less susceptible to dirt problems and adjacent switch activity. From a switching standpoint, offices of crossbar switching equipment are quite reliable for data transmission. Switching equipment of the future will be all-electronic rather than electro-mechanical and promises even higher reliability for data communications.

MESSAGE SWITCHING

Message switching is the name given to the function of transferring messages on a store and forward basis from one circuit to another in a private line system having multiple circuits. In a message switching system, the entire message is received at the communications center stored and later transmitted along the designated circuit. Any storage media is applicable to this "store and forward" concept.

Teletypewriter Switching Methods

The teletypewriter switching systems described here all have one common base, that is all storage is done in a paper tape media. The methods to be described here are manual, semi-automatic and fully automatic switching. All systems use private line facilities.

Manual Torn-Tape Switching

In a private line manual torn tape switching system, a station wishing to send a message or data to any other station in the network will always transmit the message to the communications center with the appropriate message origination and destination codes. The message is received in paper tape form at the communications center. An operator will manually tear the message off the receiving console and transfer it to an appropriate location in a tape storage rack as determined by the message destination. Sending operators will interpret the destination codes and then manually insert the tape in an outgoing transmitter which is connected to the circuit which must be used by the message to reach its final destination.

Semi-Automatic Switching

This system utilizes a continuous rather than a torn-tape operation. As before the destination code is placed in the heading of the message. Upon receipt of a message at the communication center, the operator interprets the destination code, depresses

the pushbutton corresponding to the desired station and the message is then automatically transmitted. At the end of each message the transmitter will stop and signal the operator so that another message may be transmitted.

Automatic Switching

An automatic system places a greater responsibility upon the operator of the originating station. In the systems described above the routing and control information was always visually interpreted by a switching operator. In the automatic system the sequence of codes and format must be machine interpreted and are subject to extremely rigid requirements. The incoming message is automatically fed from the tape punch to the sensing pins of the reader. The sensing pins feed circuits which interpret the codes of the designated station and establishes the connection to the outgoing line.

General Message Switching

The methods of storage in the "store and forward" concept are changing to more flexible arrangements than are available in the paper tape switching systems. Both special programmable transmission units and adaptations of general purpose computers are being used. These methods bring the ability to adapt and change to meet the growing, dynamic businesses of today.

Selective Calling & Polling

When more than two terminals are operating on the same channel, all stations will receive all messages and data unless provision is made to discriminate between the receiving parties. Conversely if all stations try to transmit it would be on a free-for-all basis (referred to as contention). To make certain that only the correct party receives a message, a method called selective calling is used whereby a station is operable only under certain selected conditions. To solve the contention problem a procedure called polling (or invitation to send) is employed. Systems utilizing these features are complex and variable in design.

Selective Calling is designed so that when the sending (calling) station precedes its message with a two-character code, only the machine assigned that code is set up to receive. In this way, the selecting device prevents stations on a multi-station line from getting unwanted traffic.

A system used for solving the contention problem (several stations trying to send at the same time) incorporates a device which will automatically permit each station to send in turn. This is known as

an automatic polling device. With this device, the communications center sends a code to start the first station. If the station has a message ready, transmission is begun. If there is none, the communications center sends a code to test the next station. Each station in the network is checked in this manner. Polling may be on either a sequential or a priority basis. In sequential polling, the communications center tests the transmitters in sequence. After the last station has been polled, the cycle is started again. The polling sequence can be modified to interrogate active stations more often than others.

Line Control

Polling and selective calling systems use certain signals and procedures to insure the orderly and efficient use of the data transmission system. This is called line control. Systems require different types of controls, depending on the complexity of the network and the volume and type of traffic. This survey of line control is not definitive, nor is it oriented towards any particular system; it serves to introduce some factors to be considered in designing or understanding the operation of a data transmission network.

In forwarding data from one terminal to another, the receiving terminal must be tested to determine whether it is ready to accept a message. If the receiving terminal is ready, the data is forwarded along with checking signals. During transmissions, the receiving station signals whether or not the data is being received properly. At the end of the message, the circuit must be left clear for other traffic. Performing these functions involves addressing, terminal status, text signals and error control.

So that the equipment may distinguish between various characters and sequences of characters different modes of operation are used. In general, two modes of operation are required; one a text mode and a second called control mode. Control mode is used to allow the equipment to establish contact and operational status. A transmission or message consists of the addressing portion in the control mode and the data in the text mode. A mode change character or sequence is used to differentiate between control and text. All addressing is done in the control mode.

To activate the stations and establish contact, each of the terminals is assigned a character or series of characters known as an address. Each device on the channel is equipped to decode the addresses that are transmitted on the line and activate the devices when they are signalled. Selections can be made of whole terminal arrangements or specific components such as printers or card readers.

The terminals addressed may respond in the same (control) mode and indicate their status. The addressed terminal can signal that it is ready to receive, ready to send, not ready to receive, not ready to send, or it may not respond at all. If the power is not turned on at a terminal or the terminal is otherwise unable to respond, the sending station does not receive an answer, and starts a "time out" or waiting period. Depending on the system, this delay can be one second to two minutes long. The time out in polling is usually very short to prevent blocking traffic. In the middle of a transmission, however, the waiting period would be longer to permit the terminal attendant to overcome the cause of the delay by such actions as clearing a card jam or replenishing the forms in a printer or slow on-line keying.

Text. --Text signals are classified as data transmission characters and text "answerback" signals. The characters from the sending terminal are used to convey the data, and sometimes include end-of-message signals, end-of-block signals, and characters for redundancy checks. The text answerback signals from the receiving station include positive and negative signals indicating whether or not the preceding message or block of data was received properly. If an answerback is not received, a time-out delay is initiated.

Error Control. --In some systems, a longitudinal redundancy character (LRC) is sent after each block of information. Other systems may use only simple character parity or the more sophisticated types of block checks. This is checked by the receiving station and the appropriate answerback signals, indicating correct or incorrect receipt, are returned. An incorrect transmission signal can be used to initiate the retransmittal of a block of data from the sending terminal

LINE CONTROL SYSTEMS

The following discussion of many of the line control services offered by the Telephone systems and Western Union is intended to be general in nature to acquaint the reader with some of the systems being offered by the common carriers. This is not intended to be an exhaustive listing or a detailed description of these systems and should not be considered as a final authority. For detailed operating procedures of any system, the operating specifications for that particular system should be obtained from the common carrier. In addition, to discuss a customer's system in any detail, a copy of his application specifications should be studied to identify which of the optional features available are being

employed in that system. Quite often details of any given system (81D1, for instance) vary from customer to customer.

In general, line control systems fall into two categories: contention and centrally controlled. Contention involves each terminal bidding for the line, with no central control. Western Union's offering in the contention area is Plan 111. AT&T has no current contention offering, other than direct point-to-point hookup between two telegraph units. Central control implies the function of a master station. In systems of more than one line, multiple master stations are located at a central point, forming a switching center. Switching between lines is accomplished in a number of ways, the simplest of which is torn tape, where a complete message, punched in tape, is torn from a reperforator, the address is read from the tape, and the tape is inserted by hand in the appropriate transmitter. Slightly more sophisticated are the directly connected reperforator-transmitters, where no manual handling of tape is required. As the systems become larger and more complex, some types of cross-office switching is provided, for example, cross-bar, electronic or computer.

While realizing that teletypewriter equipment may be assembled in an almost infinite variety of ways, some of the more popular line control systems in use today are described briefly below.

AT&T 81D1

To illustrate message switching and line control concepts in practice the important parts of the operation of an AT&T 81D1 system will be explained. The AT&T system functions in such a manner that a message may be sent from any sending teletypewriter and recorded on any desired receiving teletypewriter or group of teletypewriters in a network without requiring manual handling or operating attention other than the original perforation of tape at the sending station and the removal of the typed message from the receiving machine or machines to which it was directed. The switching operations are entirely automatic and are under the control of directing characters punched at the head of each message in the original transmitting tape and end-of-message characters punched at the end of each message.

Individual line circuits are full duplex and may be operated at either 60, 75, or 100 words per minute.

Different sizes of switching offices, the number of switching offices in a system, the number of trunks between switching offices, the number of stations in a system, the amount of traffic for local delivery in the vicinity of a switching office, the quantity of multiple-address traffic, and a number of other variations all must be considered when a system is designed.

General Method of Operation

Each station in the system is assigned a two-letter code. In order to direct a message from any sending station in the system to any receiving station, the operator perforates in the sending tape the two-character code of the desired station, followed by a "Letters" signal. The message is perforated in a tape at the station, preceded by the two-character code of the station of destination and followed by the characters "Figures", H, "Letters", which indicate the end of a message.

This tape is placed in the transmitter-distributor. No further action regarding this message is required on the part of the station operator.

The switching point serving this station polls the station and perforates the message in a tape on the receiving side of the reperforator-transmitter at the switching office.

The reperforator-transmitter is the heart of the switching system. This machine consists essentially of two parts, a receiver which perforates and prints tape identical with the tape made at the sending station, and a transmitter which transmits the signals represented by the perforations in the tape. Special tape feedout arrangements to clear messages from the transmitter are not required. The transmitting portion of the machine is arranged so that the reading of the perforated holes and the actual transmission can be controlled independently from external circuits when desired.

The presence of tape perforated with characters in the receiving side of a reperforator-transmitter brings into action an associated director circuit. The director circuit causes the reperforator-transmitter to read the first two characters, which are the code of the station of destination. These two characters are decoded by the director circuit to indicate the outlet of the switching office over which the desired station may be reached.

Outgoing Multistation Lines

It will be assumed that the station of destination is located on a multistation line. A multistation line may have up to ten receiving stations. The outgoing circuit is equipped with two reperforator-transmitters. The use of two machines in connection with an outgoing line materially cuts down the time this outlet will appear busy to cross-office circuits and permits clearing switching center queues faster.

When the director determines the outlet for the desired station, it tests the outgoing line circuit for the availability of the receiving side of one of the outlets reperforator-transmitters. If both machines are busy, the director circuit waits, maintaining its

test until one of the machines becomes idle. As soon as one of the machines becomes idle, the sending side of the reperforator-transmitter of the incoming line is connected to the receiving side of the outgoing line machine by means of the sequence circuit and the crossbar switches of the link circuit. The use of the sequence circuit prevents more than one connection from being made through the cross-bar switches during the brief period while the connection is being established, but simultaneous connections up to the capacity of the switches may exist at one time.

When a connection is made from an incoming line circuit to an outgoing line circuit, this connection is known as a cross-office connection. The directing code and the message are reperforated in the machine of the outgoing line. When the director detects the "Figures", H, "Letters" characters at the end of the message, the cross-office connection is released.

The outgoing line circuit is arranged to deliver the traffic on an alternate basis, so that traffic delivered to one machine will not receive preference in transmission over that in the other. The stations connected to a multistation line are equipped with a station control circuit including a selector unit, which is a motor-driven mechanical device for closing and locking a contact upon the reception of a number of characters received in a given sequence order. For example, a station is coded on a two-character basis and to connect a given station the characters must be received in a given call directing code (CDC).

When therefore, the coding characters are sent to the line by the outgoing line circuit, the proper station is connected and the "Carriage Return" "Line Feed" signals, which precede the text of the message, will deactivate the selector units so that they will not respond to two-character combinations in the message text that might connect other stations. The "Figures", H, "Letters" characters at the end of the message will disconnect the station and reactivate the selector units.

A station control circuit may control up to three receivers.

Outgoing Single-Station Lines

If the traffic to a receiving station is very heavy, the same type of outgoing line circuit is used, but the line is equipped with only one receiving station, and does not require a station control circuit.

Outgoing Single Trunk

The system is not limited to one switching office, but may have as many as desired. The number of switching offices is determined by the proper balance between the cost of switching equipment and the cost

of lines. Messages received at a switching office are delivered to another switching office over trunks. The single outgoing trunk circuit is arranged to deliver its traffic over a trunk to another switching point.

Outgoing Multichannel Trunks

The traffic between switching offices may be heavy enough so that one trunk does not provide adequate capacity. In this case a multichannel trunk circuit which may have a minimum of two and a maximum of ten trunks is used. Reperforator-transmitters are not used in this case as the trunks themselves provide the required multiple switching paths. The speed of transmission over the trunk must be the same as the cross-office speed, which is 100 words a minute.

Connections from an incoming line to an outgoing trunk is made on a "first idle trunk" basis.

Sending from Multistation Lines

In the previous discussion traffic was introduced into the system from a line equipped with only one station. It will be noted that all lines are full duplex, permitting simultaneous transmission both to and from stations on a line.

Multistation lines may be equipped with up to ten sending stations, as well as ten receiving stations. Since only one sending station may send at a given time, sending is controlled by a transmitter-start circuit associated with the outgoing line. Each transmitter on the line is assigned a single-character transmitter-start code which, when sent over the line preceded by a specific pattern, causes the transmitter at a given station, to start sending, if ready.

Upon termination of sending from any station on a multistation line, the transmitter-start circuit takes control of the outgoing line circuit and stops outgoing transmission. This stoppage may take place any time the text of a message is being sent or between outgoing messages. A pattern is then sent out ("Blank", a pause, "Space") which cuts off the receivers connected to the line without mutilating the copy being received and conditions the station control circuits to control their transmitters. The transmitter-start circuit then sends the start character for the transmitter next in sequence. If this next station has traffic, transmission will begin and the receivers that were cut off will be restored. If it has no traffic, the next transmitter in sequence will be tried, and so on until traffic has been found at some station or until all have been tested without finding traffic. In the latter case the circuit waits for a predetermined interval, which must be chosen to suit system requirements before again starting to test stations for traffic.

Each message in the tape at the sending station is terminated by "Figures", H, "Letters" which indicates the end of a message. However, it may not be economical to limit a transmission from a station to one message. The station operators therefore are instructed by the customer regarding the maximum number of messages that may be included in a transmission. This number may be different for each station depending on traffic needs. Following the allowed number of messages, each ending with "Figures", H, "Letters", the sequence H "Letters" is inserted. These characters indicate the end of transmission from the station. The transmitter-start circuit then polls the next station on the line.

Multiple Address

Traffic consisting of messages introduced at a sending point to be delivered to a multiplicity of receiving stations in the system is handled by a multiple-address circuit.

When a sending operator prepares a message for delivery to a number of stations, a two-character multiple-address code is perforated in the tape. The operator follows this specific multiple-address code by the codes of the stations of destination. There is no limit to the number of station codes that may be inserted. The multiple-address code instructs the director at the switching office involved to deliver the message to one of two reperforator-transmitters associated with the multiple address circuit. The whole message, including addresses and text, is perforated in one of the machines of the multiple-address circuit.

The multiple-address circuit is equipped with a special type of director which discards the multiple-address code and then starts reading the individual codes.

Assume the first code is for a station on the outgoing line. Then the reading of the address by the multiple-address director indicates that this particular outlet is required, and a bid is made to the outlet. If one of the outgoing line machines is idle, it is connected to the multiple-address circuit. This causes the multiple-address director to send the code to the connected machine of the outlet and then, without disconnecting from it, to blind the transmission path to additional addresses codes in the message header. The second address is then read and connection to another outlet made in the same manner. If another address is for an outlet already connected, the transmission path is unblinded, the new address is transmitted, and the transmission path again is blinded so that both addresses on the same line will receive the message. In like manner, all of the address are read and the required outlets connected by means of multiple transmission paths.

If an address calls for transmission to another switching office, then a trunk is connected. In connecting to a trunk, it is necessary to indicate to that trunk that this is a multiple-address message, so that it can be handled via the multiple-address message circuit in the next office. When the connection is made to a trunk for the first time, the multiple-address director inserts a multiple-address code ahead of the first address.

When all addresses have been read and sent to the various outlets, the "Carriage Return", "Line Feed" signals preceding the text are read, which causes all the connected outlets to be set in a printing condition, and the text of the message to be sent to all outlets simultaneously. The "Figures", H, "Letters" characters following the message text releases the connections.

Group Code

Part of the multiple-address traffic of many customers includes many messages which are sent to the same group of stations as a matter of routine. Considerable saving in operating time and better accuracy is obtained by assigning each of these groups a two-character code. When such a code is encountered by the multiple-address director, a group code circuit is called into action, and makes a simultaneous bid to all outlets concerned. When all the outlets involved have been connected, the multiple-address director sends the group code and the message to all these outlets.

Intercept

Different opening and closing times of stations because of time-zone differences or shutdown of stations for holidays or maintenance makes it desirable to have a means of intercepting messages bound for such a station or stations for late delivery. Such a device, the willful intercept circuit which may have one or two receiving paths, is provided at the switching office for the interception of single-address messages. The operation of keys diverts the traffic to be intercepted to this circuit. At a later time, this traffic which it stores in a reperforator-transmitter can be re-entered into the system automatically by means of its associated director.

Multiple-address messages which use individual station codes are intercepted on typing reperforators by the multiple-address intercept circuit.

Another type of interception is necessary to take care of unassigned codes which may occur from errors on the part of the operators or troubles in transmission. When an unassigned or mutilated code is encountered by either a regular director or a

multiple-address director, a miscellaneous intercept circuit is called in, which records the addresses and text on a typing reperforator. Any traffic recorded on this circuit has its addresses corrected by the switching office attendants and is re-entered into the system at an originating station.

Other Line Control Systems.

The most popular half duplex offerings by the common carriers will be briefly described below.

AT&T 83B Type Equipment

The AT&T 83B series is a half duplex 100 wpm private teletype selective calling system which consists of three versions - 83B1, 83B2 and 83B3. The 83B2 system provides a transmitter start circuit for each multistation line which controls the station that will transmit on the line. The sequence in which the stations are permitted to transmit can be fixed by the customer.

Each 83B line provides for switching of messages between stations on one line. In order to provide the switching between 83B2 lines, additional equipment is required. The maximum number of 83B lines which can automatically switch messages from line to line is nine.

The 83B station consists of a Model 28 automatic send and receive teletypewriter, a station control unit and stunt box. There can be up to forty stations on the line, but as always, the limit is determined by the application and traffic.

The stunt box performs the control functions for the teletypewriter such as carriage return, line feed, figures and letters shift. In addition, to these functions, the stunt box is equipped to recognize call directing codes (CDC) which will allow a message transmitted on the line to be printed on the ASR printer. The station control unit performs the function of recognizing transmitter start codes (TSC) from the transmitter start circuit and starts the teletypewriter transmitter.

One of the 83B stations is designated as the control station. In addition to the regular station equipment, the control station is equipped with a transmitter start circuit. The transmitter start circuit sequentially transmits the transmitter start codes (TSC) when a message is not being transmitted.

Western Union Plan 115

The Western Union Plan 115 Automatic Send Control System provides for the maximum utilization of a two-way, half duplex multipoint circuit on an automatically-selected, point-to-point transmission basis.

The system can operate at speeds of 60, 75, or 100 words per minute with as many as twenty stations on one circuit. However, fewer stations may produce better results, depending on the number and type of messages originated by, and transmitted to each station.

The system provides for continuous automatic transmission of an "invitation-to-send" sequence to each of the operating stations. If, when invited, a particular station has tape in the transmitter and is prepared to send, transmission will start automatically. If there are no messages in the transmitter, then the letter "V" is returned from the invited station indicating that no message is awaiting transmission. After completion of the invitation cycle, the canvassing reverts to the beginning of the pattern.

The number of appearances of each station in an invitation cycle for a line can be arranged to provide for differences in traffic volume at the stations. A station can appear more frequently than another as long as all appearances in each cycle for all stations does not exceed twenty. Provisions have also been made so that the order in which stations appear in the polling pattern can be readily changed by the control station operator. When such a change is made, the order of appearances of the stations is rearranged to reflect changes in message volume.

When the operator has a message to transmit, it is prepared in perforated tape form and placed under the transmitter latch. When the control units send out the invitation-to-send signal to the station, the received signal activates the station and starts the transmitter. The message address in the tape is read and the desired station is selected. After the answer-back is received from the station the message is transmitted through to the end-of-message signal. The coded end-of-transmission signal contained in the message tape will be recognized by the control unit and will restart the invitation cycle. The invitation-to-send sequence is then transmitted to the line to invite the next station in the call sequence.

When a calling station has selected a particular destination station to receive a message, the selected station returns a "V" answer-back indicating that the station is ready to receive a message. Upon receipt of the answer-back the station requests an answer-back from any additional addresses in the tape, if any. After the final addressee has been selected, the message is transmitted.

A station may transmit to any other station or stations on the circuit, or to all of them simultaneously if so required. The operator at the control point, which is usually the main office of the customer, has the ability to pre-empt the circuit for transmission of priority messages. The control

station equipment is arranged so that a station does not lose its turn to send in the invitation pattern as a result of a pre-empt.

COMPUTER MESSAGE CONTROL CONCEPTS

A message control system is a combination of methods and equipment to provide accuracy, speed and economy in internal communications, and is illustrated in Figure 51. Some of the system advantages are:

- Messages are accepted from each location under the control of the communication center. If a destination terminal is busy, the center holds the message until it can be transmitted.
- The destination address of each message is checked by the control center for accuracy.
- The receiving terminal produces a printed copy of the message, ready for delivery and timely action, without interrupting the recipient's activities.
- The printed message is a convenient reference when reviewing records and correspondence.
- All messages are conveniently numbered and dated for ready reference. The control center provides this identification, and will, on request, forward a duplicate of any message from its files.
- One message may be sent to all terminals, selected terminals, or a single terminal. The control center, under program control, retains the message and forwards it to each address designated as the respective terminals become available to receive messages.
- Individual terminals can be selected according to application requirements.
- Messages can be automatically edited at the control center, with information added or deleted, or with format changed.
- Messages are protected in the event of component failure.
- The control center operator is automatically advised when a malfunction in the system occurs.
- A data processing system can be incorporated in the system.

The Message Control Center

Since all messages moving from one terminal to another pass through the control center, the system operations and organization will be described from this viewpoint.

The control center, consisting of equipment operating under the direction of a stored program, supervises the operation of the system. Signals are accepted from and transmitted to a number of remote terminals simultaneously over communications lines. The signals received at the center are converted to

messages and stored in a direct-access file for retention until the destination terminals are ready to receive them.

The basic control center functions are described in the following sections. The flexibility of the equipment and stored-program control enables the user to determine optional handling for messages and/or data to suit individual operating requirements.

Message Identification

Messages may be identified by one or more factors, such as origin, destination, type, date, and one or more numbers. This facilitates processing and assures control over all messages at all times.

The control center verifies and assigns sequence numbers for each terminal in the network. One routine checks the incoming sequence number for each message, and another routine assigns an outgoing sequence number for each message. This provides a check that every message received was processed, and permits retrieval of messages according to incoming or outgoing sequence number.

Today's messages from online storage may be identified merely by sequence number. Older messages require identification by sequence number and date.

Message Routing

Message routing is the major function of the control center. The control center analyzes the header (address portion) of a message, determines the proper outgoing line, and directs the message to its destination.

The destination code in the message header, provided by the sending terminal, is a unique address, recognizable by the destination terminal on a multi-station line. The program used by the control center handles four different types of messages:

A single-address message, after header analysis, is placed in the appropriate queue for transmission to its destination.

A multiple-address message, after header analysis, is converted into several single-address messages, one for each address given by the sending terminal. This reduces the time required for the originating terminal to send the message, and the line time required between the originating terminal and the control center.

A group-address message contains a code directing the message to a predetermined group of terminals in the system, such as all sales offices. The group code eliminates the need for providing the address of each receiving terminal in the original message.

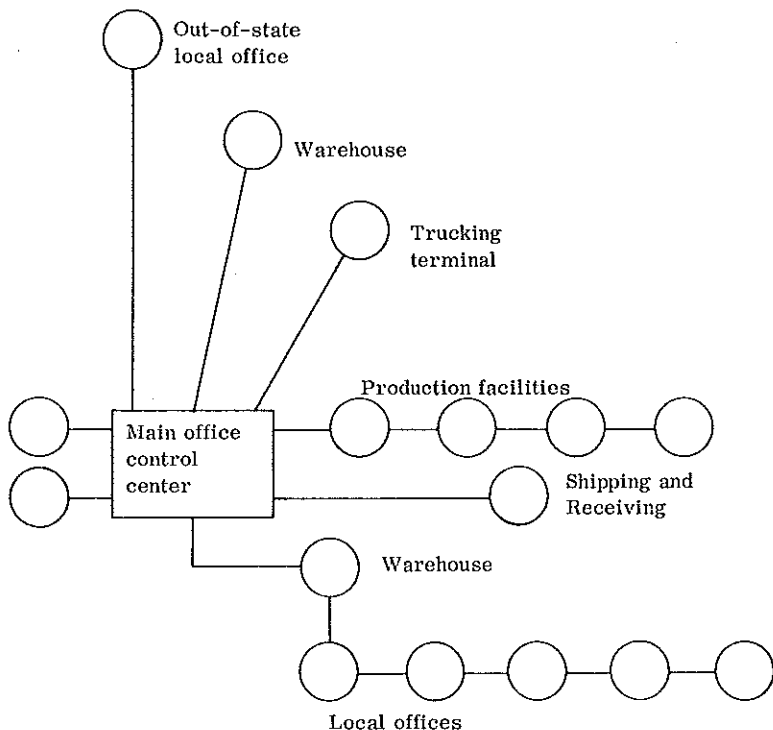

Figure 51. A message control network

A broadcast message is sent to every terminal in the system. A code in the message header is recognized by the program, which takes appropriate action to place the message in queue for each terminal.

Message Queuing

Message queuing is a technique that provides for holding messages in a waiting area within the control center until they can be forwarded to their destination. Since the arrival of messages at the control center is random in nature, there are times when several messages are ready to be forwarded to a single terminal, or to several terminals on the same line. This causes a waiting line, or queue, to be formed.

Queuing permits high line-utilization and more economical networks because of its leveling effect on traffic peaks. When traffic arrives at the center, and the destination terminal is busy, the traffic is put in line for subsequent transmission. This frees the sending terminal and its line to the center for other traffic. When a destination terminal and line become available, the control center forwards messages that have been waiting.

The availability of random access storage offers significant cost and performance advantages in queue handling. While core storage provides random access capabilities, the most practical approach is a combination of core storage and large-capacity random access equipment.

Message queuing may be handled in several ways within the control center. The approach used depends on an analysis of message traffic.

1. Organization by outgoing terminal. This method of queue organization is based on reserving an area in core storage in the communication control equipment for each output terminal. Messages are queued according to the destination terminal. This approach is advantageous when message lengths are relatively unpredictable and long messages must be segmented into several parts for storage on a disk file. Message segments are sequentially entered on and retrieved from the disk file, reducing file searching time.

2. Organization by outgoing line. This method of queue organization requires an area in core storage for each outgoing line. Since each line is normally shared by several terminals, the number of reserved areas in core storage is less than in organization by outgoing terminal.

3. Organization by incoming line or terminals. File organization based on the originating terminal or line is advantageous in special applications and message retrieval. In most applications, however, queues are organized according to destination.

Terminal and Line Control

In a message control network, each communications line to the control center is shared by many terminals. Since only one terminal can use a line at a given time, terminals will contend for the use of the line, or else some form of supervision will be required. The control of the lines and terminals is a function of the control center.

Polling is the systematic interrogation of terminals in the network by the control center. Each terminal has a unique address, and can be started and stopped by the control center. A table of terminal addresses is used by the center as a polling sequence. When a terminal is polled, a signal is sent back to the control center indicating the status of the terminal. This response, known as an answerback, indicates that the terminal is ready to send, ready to receive, or not ready to send or receive. The control center, in response to the answerback, accepts messages that are ready, sends messages that have been waiting at the center, and proceeds to poll the next terminal.

With terminal and line control responsibility, the control center can restrict or stop polling when necessary. For example, if during the normal operational day a momentary burst of traffic exceeds the handling and queuing capacity of the system, the control center recognizes this overload and restricts polling to limit the number of incoming messages. This procedure allows the total systems traffic to be processed, although some delays will be encountered during this period because of the system's "flattening" of the traffic peaks.

Speed and Code Conversion

Messages are received at the control center in the form of data bits arriving over the communications lines at the lines rated bit-per-second speed. These bits are assembled into characters, and subsequently into messages. When a message is retrieved from the disk file, the processing in core storage includes disassembling the message characters into bits for transmission.

The conversion of bits to characters and characters to bits provides the ability to receive a message in one transmission code at a certain number of bits per second, and to send the message in another transmission code at a different bit-per-second rate.

This ability allows a wide choice of terminals in the network and the use of lines suited to the message traffic load.

Message Intercept

When the control center receives a message with an incorrect header or nonexistent terminal address in the header, the program may provide for:

1. Advising the originating terminal of the error and requesting retransmission of the entire message.
2. Retention of the message until a correct header is received from the originating terminal.
3. Routing the message to a central point for correction.

Willful Intercept

When a terminal in a network is inoperative, messages directed to it must be routed to an alternate terminal or retained in the control center until they can be forwarded. This interception is usually required when a network crosses a time zone and some terminals start operations later than others. Holidays, plant vacations, local policy on weekend operations, and equipment malfunctions require messages to be intercepted.

Editing

Editing is the process by which the control center alters the content and/or format of a message by rearrangement, additions or deletions. The simplest form of editing is to enter the date and the control center message number.

Editing can reduce transmission time in some instances. For example, a report or tabulation may be received in large blocks over a high-speed line, and rearranged, with the proper headings inserted, for transmission over a low-speed line to a page printer. In this way, reports reach the control center in an abbreviated format and are then edited and forwarded so that the destination terminal receives a completed report in the proper format.

Editing may include the insertion or deletion of control characters when a message is originated at one type of terminal and received at another.

Priority Handling

Priority is the classification of messages at the sending terminal in an order of precedence, which determines the order in which the messages will be handled upon arrival at the control center. A high priority enables a message to bypass others in queue, and to be transmitted to its destination before other waiting traffic. If the capacity of the system is such that there are no queues, priority is not required.

A priority code in a message is recognized at the control center and interpreted in order to take proper action in transmitting the message to the

outgoing line. The control center must poll the terminals in such a manner that priority traffic is handled before regular traffic. On outgoing lines, priority requires the control center to place the message at the head of its outgoing queue.

There are several methods for handling priority messages:

1. Flagging. — Priority traffic can be flagged during the header analysis and before the placement of the message in the queue. On testing the queue for traffic to be transmitted, the queue can be scanned for priority traffic to be sent before normal messages.

2. Retention of priority addresses in core storage. — In this method, a priority message is placed in its normal queue position, but the sequence number and address location of the message are retained in core storage.

3. Transmission prior to logging. — This method is based upon recognizing that a message is a priority type. The message is transmitted to its destination immediately and logged afterwards.

4. Priority queues. — In this method special queues are established for priority traffic.

The specific approach to be used in a given system should feature a balance between performance and cost in terms of line utilization and storage availability.

Long-Term Message Filing

Long-term message filing is the orderly storing of all messages transmitted through the system. This file may be permanent or may be maintained for short durations. To implement long-term message filing, the control center must store complete messages for the specified period in some accessible file, and have some means of efficiently recovering individual messages. The subsequent transmission of retrieved messages can place an additional traffic burden on the system. Long-term message filing permits the terminals to retrieve messages which may have been lost or which may require additional transmissions. In many cases the technique also eliminates the need for terminals to retain a permanent traffic record.

Message retention may be selective or include the complete text of every message. Compression techniques can be used after normal operating hours to conserve space on disk packs or other storage devices.

Message Retrieval

Message retrieval is the process of searching a file for a specific message and transmitting it to the requesting location. The control center supervisor

can be advised of all retrieval requests to prevent unauthorized or unnecessary use of this function. In order to satisfy some needs for security, a terminal may be restricted by the program to the retrieval of messages which it originated or received.

Data Protection

Protection against the loss of messages due to system failure is afforded through the application of data protection techniques and restart procedures. When a terminal does not respond, or when an excessive amount of retransmission is required over a certain line, the system must provide a notification to the supervisor. In the event of a serious malfunction or power failure, the control system requires a restart procedure.

The restart is based on a complete checkpoint record written on a peripheral device such as a disk file. The checkpoint record, written at intervals, is a complete record of all messages, counters, logs, and status indicators in the system at that time. When a restart is necessary, the checkpoint record is used to restore the system to its condition at the time the checkpoint record was written. Each terminal is advised of the restart, and the number of the last message properly received from the terminal at the time of the checkpoint. Subsequent messages are retransmitted, and the system is again operational.

Error Control

Some terminals provide features to aid in detecting transmission errors. In operation, the terminal compiles and generates a check character based on the number of bits in the message for transmission after the last character in the message or the last character in a portion of the message. This character is compared with another check character generated in the same manner at the control center to determine whether the proper number of bits and characters have arrived. If the check characters agree, an acknowledgment is sent from the control center to the terminal, indicating that the message has been properly received. If the communication lines have introduced errors, the control center sends back an indication that the message or block has been distorted along the transmission path. Terminals can be provided with the capability to perform one of two actions when an error indication is received: (1) alert terminal personnel by audible signal, or (2) automatically retransmit the message that was previously in error. If automatic retransmission is unsuccessful, an attendant is usually notified by means of an audible signal after a preset number of attempts.

To give the terminal operator some degree of assurance that the message is being properly received by the control center, it is desirable for the terminal to recognize a "message correctly received" response from the control center. Where error detection and correction cannot be provided, some acknowledgment from the control center, which indicates that it has received a message or that it is still on line, should be sent at the end of the terminal's transmission. The user must be willing to allot some portion of his line time for acknowledgment signals in order to obtain the benefits of error checking.

Cost factors dictate whether errors in administrative traffic should be allowed to go undetected. In most administrative messages the reader can usually correct minor errors mentally. However, where large amounts of important numerical information are being transmitted, a communications channel error could be serious. The impact of numerical errors should be weighed against the economics of specifying extensive error detection and correction procedures.

COMMUNICATIONS COMMON CARRIERS

Communications common carriers are companies which furnish communications services to the public. They are regulated by the Federal Communications Commission or appropriate state agencies. Their services include communications facilities for voice, data, facsimile and printed messages, as well as appropriate communications channels for television, telemetry and telephoto. In the United States approximately 2,800 companies are recognized as communications common carriers. These companies can provide complete communications services to the subscriber including channels, modulating equipment, and the necessary terminating arrangements. Alternatively, the customer may lease only the channels and provide purchased or leased terminal equipment for data communications.

The services mentioned in this section are presented as a survey of some of the communications facilities available today. The representatives of the communications companies should be consulted in order to obtain current information on rates, availability of service, billing arrangements, channels and related devices pertinent to data transmission.

THE FEDERAL COMMUNICATIONS COMMISSION

The Federal Communications Commission, an independent federal agency, regulates interstate and international communications originating in the United States, such as radio, telephone, telegraph, facsimile, telephoto and other broadcast program transmissions by wire, cable or radio.

The Communications Act, establishing the Federal Communications Commission, requires that every common carrier furnish service at reasonable charges upon reasonable request. No carrier may construct, acquire or operate interstate or foreign facilities originating in the United States without the approval of the commission.

Under the provisions of the Communications Act every common carrier must file with the commission schedules showing all charges, practices, classifications and regulations for interstate communications services offered to the public. These schedules, known as tariffs, are normally filed at least 30 days before their terms become effective. The tariffs form a significant part of the machinery by which the commission enforces the duties and prohibitions imposed on the common carriers for the benefit of the public. They are also the basic contract between the common carrier and the user. Telephone and telegraph companies are not required to file tariffs of their own if they concur in the tariffs filed by other common carriers. Due to local conditions, however, tariffs may vary from company to company.

One example of a tariff with a high degree of concurrence among a large number of telephone companies is tariff #245 filed with the Federal Communications Commission by the American Telephone and Telegraph Company. This tariff covers the V-H Measuring Plan. It establishes the basis for determining the cost of a telephone call by providing a uniform means of calculating the distance between the calling station and the receiving station.

STATE UTILITY COMMISSIONS

Intrastate common carrier communications service is subject to regulation by state commissions similar in function to the Federal Communications Commission.

INTERNATIONAL TELECOMMUNICATIONS UNION

The International Telecommunications Union is an administrative international organization responsible for the allocation, registration and utilization of the radio frequency spectrum. The main objective of the

union is to maintain and develop international cooperation for the improvement and rational use of communications. The union undertakes studies and issues recommendations for the benefit of all members, as well as participating in the Technical Assistance Programs of the United Nations. Within the ITU, the Consultive Committee on International Telephone and Telegraph (CCITT) and the Consultive Committee on International Radio (CCIR) are actively engaged in the standardization and coordination of international worldwide communications facilities.

THE BELL SYSTEM

The parent company of the Bell System is the American Telephone and Telegraph Company, incorporated in 1885, which owns all or part of the stock of 23 associated operating telephone companies and the Western Electric Company. Together with Western Electric, AT&T owns the Bell Telephone Laboratories. Western Electric manufactures, purchases, distributes and installs equipment to fit the needs of the Bell System. Bell Telephone Laboratories is the research development unit of the Bell System.

The people of the Bell Telephone System design, build, operate and maintain facilities for approximately 74 million telephones in 48 of the states and the District of Columbia. Bell System lines connect with telephone systems in all 50 states of this country and throughout the world.

The Bell System provides a wide range of products and services to fit specific communications needs, from the basic telephone instrument to DATA-PHONE Service which enables business machines to communicate via the telephone network in the same way people do. The technological contributions of the Bell System include the invention of the transistor and the solar battery, as well as the designing and building of the Telstar satellites. Touch-Tone calling, which will replace the rotary dial with pushbuttons, and completely electronic telephone call switching are being developed to improve the service of the Bell System to its customers.

Some of the communications services of the Bell System are Wide Area Telephone Service (WATS), Telpak, Teletypewriter Exchange Service (TWX) and DATA-PHONE Service.

WATS

Wide Area Telephone Service is arranged for subscribers who make many long distance calls to many points. Monthly charges are based on

the size of the area in which the calls are placed, not on the number or length of calls. Under the WATS arrangement, the United States is divided into six zones. The subscriber is billed a flat rate according to the zones to be called on a full-time or measured-time basis. This can be an advantageous arrangement for data transmission.

Telpak

Telpak service is a pricing arrangement that makes available wide band communications channels of various sizes suitable for large-volume point-to-point transmission of data, voice, teletypewriter, facsimile, or other services for a flat rate regardless of usage. Telpak can be used as a single large channel or a group of smaller channels. For example, a Telpak "A" channel may be divided into 12 voice grade channels.

Teletypewriter Exchange Service

Teletypewriter Exchange Service (TWX) provides direct dial point-to-point connections using input/output equipment such as page printers, keyboards, paper tape readers and paper tape punches.

DATA-PHONE Service

DATA-PHONE Service provides for the transmission of data between a variety of business machines, using regular local or long distance telephone networks, or WATS lines. The cost to the customer is the same as an ordinary telephone call in addition to a monthly rate for the DATA-PHONE data set.

Other Services

In addition to the familiar dial telephone services, voice grade and telegraph grade lines, can be leased for the exclusive use of the subscriber.

GENERAL TELEPHONE AND ELECTRONICS CORPORATION

General Telephone and Electronics Corporation is a highly diversified communications and manufacturing enterprise whose operations throughout the United States and abroad are known as the "General System". GT&E, through its telephone operating and manufacturing subsidiaries, provides communications equipment and services ranging from telephone service for the home and office to complex voice and data systems for industry and national defense. The General System serves nearly 7,200,000 telephones through some 30 domestic

telephone operating subsidiaries and two international subsidiaries located in British Columbia and the Dominican Republic. The domestic telephone companies constitute the nation's largest independent (non-Bell) telephone system, serving about 40% of total independent telephones.

The General System offers a wide variety of communications services in addition to basic telephone service, including Wide Area Telephone Service, Telpak, direct dial teletypewriter service, and DATATEL services. TOUCH CALLING telephones are now being introduced, and field trials of the E-A-X electronic automatic exchange are currently under way to bring further improvements in service to customers of the General System.

The General System has had broad and extensive experience in the data communications field. Over the years, many services utilizing channels ranging from narrow-band telegraph up to four-megacycle video channels have been provided. General System companies offer, under tariffs, all data services of the common carriers. The equipment utilized in providing data communications is developed and manufactured by GT&E subsidiaries where practicable. GT&E equipment is compatible with the equivalent Bell System equipment, thus permitting direct interconnection of services. Special arrangements are provided when needed to meet individual requirements.

Automatic Electric Company, a manufacturing subsidiary of GT&E, produces communications equipment for the independent telephone industry. Lenkurt Electric Co., Inc., another subsidiary, manufactures data sets, microwave radio, and carrier multiplexing equipment for commercial and military communications.

INDEPENDENT TELEPHONE COMPANIES

The General System and balance of the 2,550 telephone companies operating 14 million telephones in the United States provide services that interconnect with the Bell System and each other. There are 140 independent telephone companies that have more than 10,000 telephones, and 112 that have between 5,000 and 10,000 telephones.

The United States Independent Telephone Association (USITA), with headquarters in Washington, D.C., represents many of the independent telephone companies. It provides guidance to its members and coordinates their practices through committees. The USITA publishes Annual Statistical Volumes, which can be purchased. "Telephony Magazine", published weekly by the Telephony Publishing Corporation of Chicago, and "Telephone Engineer and Management", published semimonthly by the Telephone Engineering Publishing Corpora-

tion of Chicago, are important vehicles for distributing information about the telephone industry. Both companies publish annual directories indicating the corporate structure and pertinent statistics about telephone companies in the United States.

WESTERN UNION

The Western Union Telegraph Company, incorporated in 1851, has played a vital role in the development of communications in the United States.

The company furnishes communications services by wire and microwave radio throughout the United States. It provides the only national telegraph message service. It also furnishes custom-built private wire systems and facsimile systems on a leased basis and Telex, a direct-dial teleprinter service.

Western Union leases more than 2,000 private wire systems of varying sizes and speeds for industry and government. It recently placed in service for the Department of Defense an advanced digital data network (AUTODIN) with a capacity of 12,000,000 punched cards, or the equivalent of 320,000,000 words daily.

Western Union recently expanded its offerings of leased wire facilities to include a full range of voice, alternate voice-record, Telpak and voice-data services. It also leases circuits and equipment to speed communications by facsimile.

Western Union nationwide microwave network, which is capable of accommodating all modern forms of communication at high speeds and in large volume, is being extended to serve new AUTODIN centers and it is planned to extend this system from San Francisco through the Pacific Northwest. It will provide high-quality microwave circuitry for voice, facsimile, and high-speed data as well as public message and private wire services.

ITT WORLD COMMUNICATIONS, INC.

ITT World Communications, Inc., is one of twelve telecommunications operating subsidiaries of the International Telephone and Telegraph Corporation. Together, these companies make up the ITT World Communications System, a worldwide network of more than 1,000 international circuits linking 20 countries with each other and with every major communications distribution center in the world.

The ITT Worldcom System offers to customers around the world international telegram service, Telex, private leased channels, international data transmission with voice control, international Datel, Datatelex, radiotelephone, ship/shore message and Telex service, press-cast and other press services, facsimile and other visual transmission including television.

The ITT Worldcom System has developed from a recent realignment of the ITT international communications operations in the U. S. and abroad. ITT World Communications, Inc., consolidates the U. S. operations of four of these companies, formerly identified as the American Cable & Radio System. Other members of the ITT World Communications System are Press Wireless Inc. (U. S. and certain foreign points), Globe-Mackay Cable and Radio Corp. (Phillipines), The Commercial Cable Company (U. K. and Canada), All America Cables and Radio, Inc., and other companies in the Caribbean and Central or South America.

Major operating centers are in New York, Washington, D. C., San Francisco, Honolulu, London, Manila, San Juan, P. R., Rio de Janeiro, Lima, Panama, Santiago and Buenos Aires. More than 110 international traffic offices are in service in these and other cities.

Customers in cities not served directly by ITT Worldcom offices use ITT international facilities through the intermediate services of domestic carriers, such as Western Union or the Bell System in the U. S., or, in many other countries, through either domestic or international carriers. This applies to the full range of services offered.

The ITT Worldcom System operates through the full range of technical media: coaxial and conventional cables, both submarine and landline; HF and UHF radio including over-the-horizon tropo-scatter; satellite circuits.

Technical advances in the international communications field include the automatic message-handling center now in service in New York, and automatic Telex switching centers operating in New York, San Francisco, Honolulu, Washington, D. C. and San Juan. In addition, special facilities for inter-continental data processing systems are designed for specific applications.

RCA COMMUNICATIONS, INC.

The Radio Corporation of America was created in 1919 to provide international communications facilities. Ten years later RCA organized a subsidiary company, RCA Communications, Inc., to concentrate solely on the further development of international communications.

Today, RCA Communications' network consists of more than 1,000 radio, coaxial cable and satellite channels which provide international message telegraph, Telex and leased channel service to practically every country in the world. In addition, RCA Communications maintains facilities for photo transmission service with 56 overseas points, telephone service between 14 terminals in the Pacific, marine telegraph service to and from

ships at sea, television transmission service between the United States and Europe, and program broadcast service for news services in all parts of the world.

RCA Communications furnishes private leased channel communication services to all parts of the world. More than 250 such channels for teletypewriter, telephone, facsimile and data communications are in use. RCA also provides two data transmission services -- Datal and Datatelex -- for firms requiring international data transmission.

At present, almost 200 circuits are operating through the Electronic Telegraph System in New York. ETS electronically routes, processes, and transmits telegrams overseas. Similarly, it guides messages originating overseas to their domestic destination automatically and without manual handling. RCA is also automating its Telex network to permit subscribers in the U. S. to direct-dial subscribers in the major countries of the world. The automated direct-dial system utilizes area codes similar to those used in making long-distance phone calls within the U. S.

PRIVATELY OWNED COMMUNICATIONS SYSTEMS

The federal government and some industries purchase, maintain and operate some of their communications facilities. Examples of these private systems are telegraph and telephone systems owned by railroads and pipeline companies operating in remote areas. Licenses can be obtained to operate private radio and microwave systems under certain circumstances.

NETWORK DESIGN

INTRODUCTION

Network design in the broad sense of the term is the name applied to the technique of selecting the terminal facilities, choosing the data communication services and equipment, and the matching of these selections to the network control devices. The result should be the most effective design when considering the functional performance in relation to the cost. A good network design requires a full knowledge of the communication traffic and a thorough understanding of the system functions.

A data communication network refers to a combination of communication channels used to move data between geographically separated points. Such channels take many forms as has been previously shown and a network of these channels can be as simple as two machines interconnected by a single channel or as complex as a nation-wide system with several processing centers and many stations

using combinations of leased and switched facilities. The more complex the network the more difficult it becomes to make accurate determinations of message response times and total capacity, but a design must be completed before a thorough understanding of the system component interactions can be achieved. Network design becomes an iterative procedure because of this interaction and careful decisions about data communication facilities and equipment must be made.

DATA ANALYSIS

Although much has been written about the gathering of data for the design of systems it cannot be stressed too heavily in network design. The total system operation may depend on the accuracy and validity of the design data and assumptions. The forms described are meant to be an aid and starting point reference and not all inclusive.

Remote Station Description

To initially define the necessary data it is helpful to specify the complete function of each remote station. This functional requirement will be the primary input to the terminal selection procedure. A preliminary selection of the terminal must be made so that the characteristics can be applied to the network traffic statistics.

At the time of the initial selection it is important that all of the terminal factors be considered. The document requirements of the data types to be handled will decide the type of equipment needed; i. e. cards require punching/reading, printed output requires a keyboard and card or tape buffering, etc. Also the characteristics of this data governs how the terminal will operate: for example, an inquiry terminal would have its keyboard polled for inquiries and then its paper tape reader for batch type transmissions.

Operational Description

The mode of operation is also determined by the type of data. A full duplex line is only slightly more expensive than a half duplex line, but moving traffic in both directions at the same time may not be possible in many applications. Also, the terminal cost will increase with full duplex operation.

The need for error detection and correction can be decided from the contents of the data to be handled. If the messages contain ordinary words and are not to be processed by the computer, then error correction probably will not be needed. If coded information or numeric data are included or if processing is to be done, checking is generally justified. In cases where more than one level of accuracy is required the most demanding application

will be generally accepted as the criteria.

The speed of operation is not easily decided. Establishment of the speed criteria is made only after thorough study to assure that all possible solutions have been investigated. In general, terminal speed is determined by application requirements and not by other considerations.

If existing terminals are to be used, their operation must be clearly defined and understood. Some consideration should be made for terminal operation, not only under error condition but for procedural back up necessary as required by the application criteria. All of these things must be evaluated and documented as requirements on the network design.

TRAFFIC ANALYSIS

Ideally a peak period is carefully determined from sampling over an extended time period. Care must be taken to get a true peak based on origination rather than on activity of existing channels. This peak period used for the network design must be the system peak, and is not necessarily one hour long. The application will determine an acceptable peak duration.

Traffic peaks can occur with either time or geographic factors. First to be determined is the business cycle peaks. These can be either annual or seasonal in nature as might occur in retail business. One peak would occur at the Christmas season with other secondary peaks at Easter or in the fall before school openings. The data collected for use in the network design must identify such peaking conditions. Other peaks can occur by the month or by the day of the week. Still other peaks occur by geographic location and more by time zones. A solid understanding of the business peaks, their causes and effects is necessary for the design of an effective communication network.

Figures 52 thru 55 show the layout of some helpful forms used in the development of the statistics. This will result in an understanding of the traffic characteristics of the system. The following are some considerations affecting traffic statistics:

1. Application and Operation

After developing the system transaction summaries based on origination frequency, the actual character volume must be determined. For each transaction type at each terminal location the total number of characters sent and received must be developed. While average message length may be easier to use the application may dictate that actual counts are necessary. In addition to the

Present Transaction Types

Transaction Name	Description of Transaction (include the time it takes and the means of communication)

Figure 52.

Proposed Transaction Types

Proposed Terminal Locations	Transaction Name	Description of Transaction (Include desired timing improvements)

Figure 53.

Day _____ Date _____ Transaction Volume Survey

Terminal Location _____

Time Converted to a Std.	Time, Starting	NUMBER OF TRANSACTIONS					
		**	**	**	**	**	**
PRIOR	PRIOR						
	8:00						
	8:15						
	8:30						
	8:45						
	9:00						
	9:15						
	9:30						
	9:45						
	4:00						
	4:15						
	4:30						
	4:45						
	5:00						
	5:15						
AFTER	AFTER						
TOTAL							

** Transaction Name

Figure 54.

Day _____ Date _____ Summary of Transaction Volumes

Summary of _____

Time Converted to a Std.	Time, Starting	Possible Peak Hour	TOTAL NUMBER OF TRANSACTIONS						TOTALS		PEAK
			**	**	**	**	**	**	Time, Seconds	% of Time	
PRIOR	PRIOR								(a)	(b)	
	8:00										
	8:15										
	8:30										
	8:45										
	9:00										
	9:15										
	9:30										
	9:45										
	10:00										
	4:00										
	4:15										
	4:30										
	4:45										
	5:00										
	5:15										
AFTER	AFTER										
TOTAL											

* Enter average transaction time, seconds ** Transaction Name

Figure 55.

actual message characters the following factors must be calculated and added to each message type:

- a. Polling time
- b. Card Reader Timing
 - 1) Feed time
 - 2) Eject Time
- c. Printer Timing
 - 1) Forms feed
 - 2) Tabbing
 - 3) Carrier Return
- d. Checking Time (including line delays)
- e. Keyboard (on-line keying factors)

Each transaction type must be analyzed for these factors and total message lengths determined. Figures 56 through 58 show some usable formats to aid the network designer. The character load at the terminal has now been determined and the adjustment factors that follow will be used to change these totals to realistic values.

2. Growth Factors

The traffic increases that will occur as a result of the company's growth will affect each of the transactions. Typical growth is five through ten percent per year but it is wiser to use the actual

figures if they are available. This growth is of particular importance because the time between when the network is designed and the system installation may be one to two years. If this time is added to the proposed system life of approximately five years, it can make a significant impact on the traffic load.

Growth will not only be attained through normal business increases but may be produced by new business ventures or company acquisitions.

3. Turnpike Effect

The traffic increases in a data communication system must include the turnpike effect. This phenomenon was first noticed when the initial super highways were opened. The plans for the traffic loads were based on the assumption that people would continue to use the old facilities. When the highways were opened not only did the people stop using the old facility but more people used the new road and significant travel increases were noted. The causes for this traffic increase in a data communications system would be:

- a. The system provides more information than was previously available.

Line No.	PRINTER FORMAT FOR (TRANSACTION NAME):				60 120	Total No. of Char.	Oper. Keyed Char.	Comp. Gen. Char.
	1	10 70	20 80	30 90				
1								
2								
3								
4								
5								
6								
7								
8								
9								
10								
	TOTALS →				60 120			

Printer Transaction Format

Figure 56.

When definite response criteria are given, they are usually in the form of X% of messages delivered in Y or less minutes. This time will include all transmission and queue time. Care must be exercised that these figures are realistic and apply to all of the traffic handled in the peak period. Sometimes several sets of X and Y are given such as 50%, 80%, and 95%. If response time is the desired criteria, it must be converted into line utilization so that the channels may be loaded. Experience has shown that if specific response criteria are not known, an 80% loading will provide a reasonable compromise between response and economy.

One other possibility in channel loading is the possibility of keeping the line open for the reply to an inquiry. Although generally it is not possible through the terminal controls, it is possible under the control of the computer program. This means that the line would be seized at the beginning of an inquiry and not released for subsequent use until a reply is received. If there is more than one terminal on such a line the wait time might become intolerable. When specifying more than one terminal on a line and the traffic is light, check to make sure that the selected terminals do not have a pre-established maximum or that you load the lines in such a manner so as not to exceed the maximum.

CHANNEL LOADING

An expansion of the data that has been gathered must now be made so that the network design can be accomplished.

Terminal Locations

Each geographical location must be defined. If there is more than one location within a city, each location should be shown separately. This list should include all locations to be served during the proposed life of the system. The initial system may be designed so that expansion plans as described previously under "Growth Factors" would be easily accomplished. The proposed data summary sheets reflect the terminal locations selected.

Central Switching Locations

Ideally, the machine which will control communications among the terminals is located at the weighted center of the terminals. Actually, other considerations almost always dictate the locations. If you are free to locate the machine, pick a city near the

apparent geographic center of a map showing all locations, then move toward the more heavily loaded terminals. It may be necessary to pick several different centers in order to find the most economical. In picking a central switching location, keep in mind the need for communicating with other computers, a function that is not readily apparent from studying only terminal locations. Some systems can economically support decentralized switching. This is a matter of trial and error depending on equipment cost and location.

Present System Description

A present system description will provide much of the information and may well be a foundation for the new system design. Two important advantages that may be realized are:

1. By using existing terminals and/or message formats, a minimum of remote confusion will result at change over.
2. The present system may use communication lines which are more economical than those a new design might require, due to existing customer-owned channels or unused commercial facilities.

Operating Periods

Make sure that the specified operating periods take full advantage of rate structures of the various based facilities. Each location should be time zoned and corrected for operation with the central.

Operating Constraints

The data, as collected, should allow for the burdens of the system. A check of all data should be made to insure corrections and the inclusion of all exceptional procedures and constraints. Some of these are rigorous verification or error checking routines, direct communication and message switching, particular speed, inexperienced or part-time operators or unusual environment.

Terminal Selection

The simplest system will have the same basic terminal at all locations, but this is not necessary. In fact the application analysis and the data gathering have specified the functional requirement. Now the choice of terminal is one of speed and code to conform to the total system environment.

MANUAL DESIGN - LEASED NETWORK - UTILIZATION CRITERIA

The following steps are recommended:

1. Establish total traffic for each terminal as outlined in the preceding steps.
2. Apply terminal speeds. These must be consistent with the communication facility speed. (A good working unit at this time is characters per hour.)
3. Establish the line loading limit in the same units as the location loads.
4. Plot the terminal locations on the map. A map is necessary for a manual network design. A large scale map showing as many locations as possible is good but any map showing all the places to be interconnected on one sheet is satisfactory. For manual design the scale must be quite accurate in all directions, such as on a "conformal conic" projection.
5. Select the switching central location (DPC).
6. If there are locations that exceed the maximum line load, split each such location into the number of maximum load lines with one terminal each and one terminal for the remainder. The full load lines and terminals may be listed separately.
7. Start the selection process by picking a location farthest from DPC. Begin to link the locations by summarizing the location loads until the line loading maximum is reached. The points selected should be connected on the map. Keep line mileage to a minimum by pointing the line towards the DPC with narrow lateral detours to pick up locations. Remember that the number of terminals on a line may reach its maximum before the line is loaded to criteria.
8. When one line is completed another should be made using the procedure in step 7. When several lines in one section of the map have been defined, a review should be made to try different combinations that may be shorter.
9. Continue steps 8 and 9 until all locations have been linked with the center.

Leased Line - Response Time Criteria

When the critical design parameter is the response time (as previously discussed) it becomes necessary to convert this parameter to line utilization, thereby enabling us to design the network as outlined above. This section presents a graphical method of finding the necessary line utilization, given the required response time or vice versa. The graphs are based on a simulation model for a message switching network and have been normalized to make them independent of line speeds and

message lengths. It is necessary that the user fully understand the following parameters and assumptions before a use of the graphs is attempted:

1. Assumption and Parameters for Half Duplex Model.

In establishing a network model, there were a number of parameters or variables that could have been considered. It was necessary to make the model as widely applicable and practical as possible.

a. Line Loading

All terminals on a line are assumed to be equally loaded. For an imbalance in terminal loadings a variation of the polling scheme to favor the heavily loaded terminals should make the curves developed applicable.

b. Polling Scheme

The terminals are polled sequentially with a maximum of one message being accepted per terminal in one pass through the polling list. Output messages are handled on a priority basis with a check for output being made after each input message and after each complete pass through the polling list. The output queue for the line is exhausted at each check point with the first message in the queue being transmitted first.

c. Number of Stations Per Line

Several runs were made for various length messages on lines with 2, 6, and 10 stations. It was found that the maximum deviation from the 6 stations was 10% within 2 to 10 stations. Therefore, only the 6 station curves are shown and they are considered valid for 2 - 10 stations.

d. Ratio of Input to Output

One of the important considerations in message switching systems is the ratio of the number of input messages to the number of output messages in the system. This ratio will be called R_{IO} . Generally, R_{IO} will be 1:1.1 or slightly more messages out than in. This 1:1.1 ratio is due to a small number of multiple address messages. The curves shown can be used for an R_{IO} of from 1:.7 (less out than in), to 1:2, (twice as many out as in).

More output than input would tend to increase message response time, while less would have the opposite effect. There are two sets of curves. The first set, graphs 1 and 2, is to be used where

Graph #1.
 Y_U
 vs
 Line Utilization
 R_{IO} from 1:7 to 1:1.4

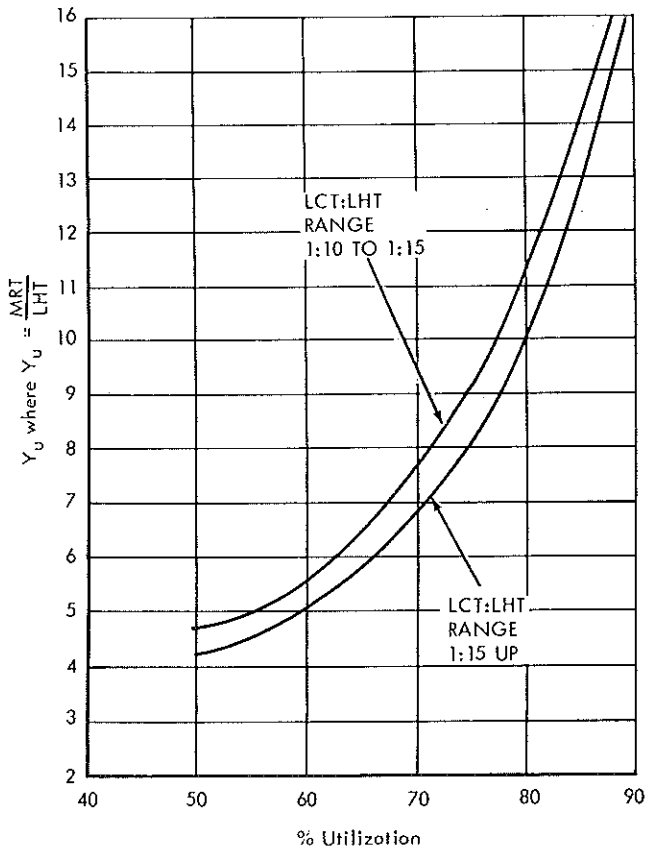

Graph #2.
 Y_P
 vs
 Percentile
 R_{IO} from 1:7 to 1:1.4

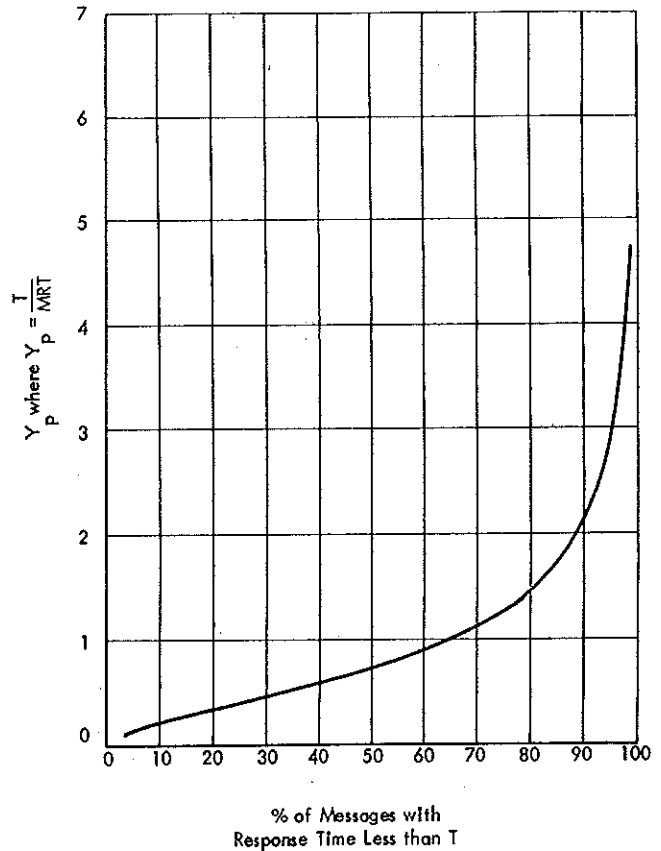

the R_{IO} falls in the range of 1:7 to 1:1.4. The second set of curves graphs 3 and 4 is to be used where the R_{IO} falls in the range of 1:1.4 to 1:2. These curves hold to within 10% for any R_{IO} in these ranges.

e. Message Generation

Messages are created or are assumed to arrive "randomly" in time at each terminal, that is, follow what is termed a Poisson arrival distribution. The distribution of the message lengths (discussed under Line Holding Time) is assumed to be exponential which may be considered a worst case condition. Constant message lengths would yield considerably better results at higher line utilizations. The output messages are generated by the multiplexor and the model was run with the assumption that output messages will not be returned to the same line that initiated the input message. The use of the response curves is limited by the number of lines

in a system. That is to say, the curves are more accurate for a 10 line system than for a 5 line system where a larger percentage of the messages might be sent back on the same line.

f. Line Holding Time (LHT)

For this model and the resultant curves, the message length is represented as the Line Holding Time or LHT. LHT is the total line holding time for the transmission of a message plus the single poll or selection time that caused that message to move. The LHT includes such fixed functions as End of Block, End of Message, line turn around time etc., where applicable. The LHT may be expressed as character time units or in time units such as seconds. The LHT is thus independent of line speed and actual message length.

g. Line Control Time (LCT)

In this model as in most message switching systems, all that time not used,

Graph #3.
 Y_U
 vs
 Line Utilization
 R_{IO} from 1:1.4 to 1:2

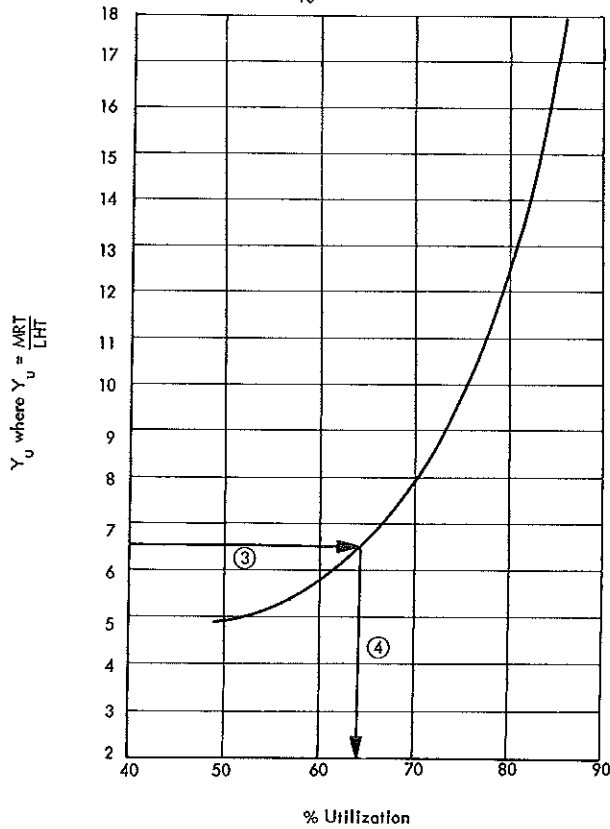

by LHT, is used for unsuccessful polls. LCT is thus the time taken for one unsuccessful poll. The critical factor in normalizing the results of this simulation was found to be the ratio of LCT:LHT. The time to poll for a "no" message response, poll a message or address a terminal is assumed to be 8 characters for this model. (The 8 characters is normal for polling and addressing in many message switching systems)

It was found that in the R_{IO} range of 1:1.7 to 1:1.4, the curve for a 100 character message, with an LCT : LHT ratio of 1:13.5, was significantly different from that for a 300 character message, LCT : LHT ratio of 1:38.5. Thus there are two curves for this R_{IO} range. The upper curve in Graph 1 holds within 10% for LCT : LHT ratio of 1:10 to 1:15, and the other curve holds within 10% for LCT : LHT greater than 1:15.

Where R_{IO} is from 1:1.4 to 1:2 there is no significant difference due to change

Graph #4.
 Y_P
 vs
 Percentile
 R_{IO} from 1:1.4 to 1:2

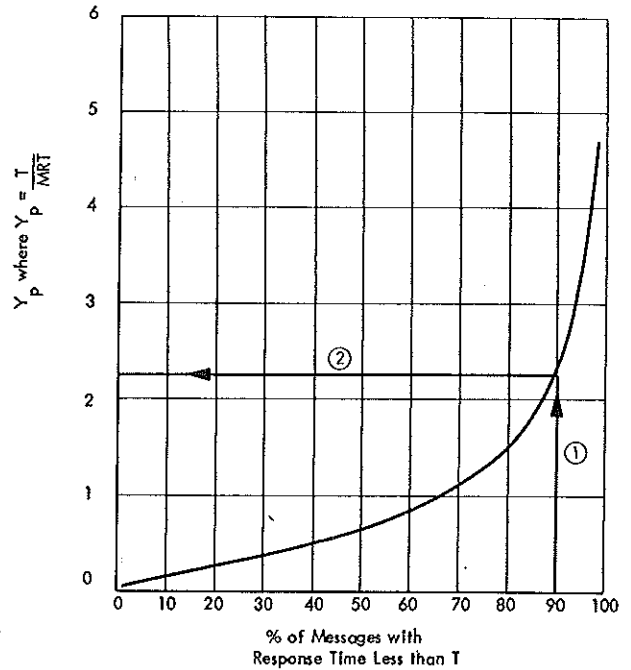

in the LCT : LHT ratio. Thus there is only one curve for this R_{IO} range. The one curve is valid to 10% for any LCT : LHT ratio greater than 1:10.

h. Mean Response Time (MRT)

In this model we define round trip response time as the time from request-to-send to receipt of last character by addressee. This time includes queue time at terminal, transmission time into CPU, queue time at CPU, and transmission time but to addressee. Message handling or process time by CPU is neglected as it is normally a fixed amount of time and is usually too small, in comparison to transmission time, to be of significance to the model. The Mean Response Time is the statistical mean of the round trip response times.

2. Use of Curves

In order to use the curves for a system, the following parameters must first be determined:

- Average message length
- Polling time or length = LCT
- R_{IO}
- LHT

There are three design parameters, maximum line utilization (U), system

response time (T), and the percentile of messages (P) that must meet the system response time. Knowing any two parameters, we can find the third by using the curves. Thus if in our system 90% of the messages must experience a round trip response of 5 minutes or less, then we have that P = 90% and T = 5 minutes or 300 seconds. We can now use the curves to find the maximum line utilization, U.

Conversely if the maximum line utilization is given, say 70%, we would like to know what kind of response time most of the messages in the system will experience. Knowing the response time we could then ascertain if the given line utilization will permit us to adequately service the system. For example, we may have been given U = 70%. We will have to pick a P, say 90%, and now we could find T, the response time for most of the messages.

There are two sets of graphs. The first covers an R_{IO} range of 1:1.7 to 1:1.4 and the second set of an R_{IO} of 1:1.4 to 1:2.

The first graph of each set (1 and 3) express the relationship between the utilization (U) and Y_u, where $Y_u = \frac{MRT}{LHT}$.

The second graph of each set (2 and 4) expresses the relationship of the percentile (P) to Y_p where $Y_p = \frac{T}{MRT}$. Thus if we are given a design criteria of 90% of the messages in 5 minutes or 300 seconds for a system where the LHT = 20 seconds. By knowing the R_{IO} say 1:15, we can find U.

We have given

P = 90%

T = 300 seconds

LHT = 20 seconds

Y_p is found by entering Graph 4 (proper R_{IO} range) at 90% and going up to the curve and over the Y axis. Y_p = 2.3

$$Y_p = \frac{T}{MRT} \text{ or } MRT = \frac{T}{Y_p}$$

$$= \frac{300}{2.3} \text{ seconds} = 130.$$

We now know the MRT and have been given LHT. Therefore $Y_u = \frac{MRT}{LHT} = \frac{130}{20} = 6.5$. Entering graph 3 at Y_u = 6.5

and reading over to the curve and down we find that U = 64.5%. Thus if each line in the network was loaded to no more than 64.5% of its total message handling capability then 90% of the messages in the system would experience a round trip response time of 5 minutes or less. Notice that to use the graphs we first had to make the units between T, the time, and LHT consistent.

As an exercise trace the alternate path where given a 70% utilization and an LHT of 20 seconds and R_{IO} of 1:15 we find that 90% of the messages have a round trip response of _____ . Answer is T = 6.01 minutes.

Switched Network

1. All Switched Terminals

When the traffic pattern (origination/destination patterns of all messages) is entirely point-to-point among many different points, with all locations lightly loaded, it may be economical to use Telex or TWX for this traffic. The Telephone System can handle higher speed if there are large amounts of such traffic and the Wide Area billing arrangement also becomes attractive for this. This type of system, however, offers no central control of traffic and assumes no one major origination/destination point -- hence, no "central" machine configuration for on-line processing. The design of such a system is generally quite approximate, with the number of terminals required at each location based on the peak period send-plus-receive load, the HDX terminal speed, and the amount of control time to get a connection before moving data (see 3. below).

As an example, the system design for a TWX network might be to have the terminals call the computer central processing unit (CPU) when a transmission is required. If this is the case then the network cost and number of TWX access lines could be found in the following manner. From the traffic statistics for each terminal, the number of calls per day per terminal could be obtained. This would require knowing type of message, message length, transmission method, and other information discussed. By knowing the location of each terminal, the distance to the CPU can be found by the V-H coordinate method.

2. Some Switched Terminals

Since most data communication networks require some sort of central on-line processing, and leased lines are generally more economical for such traffic, switched terminals usually appear as only part of a communications network.

They are used for one or more of these reasons:

- a. To back-up other lines and/or machines for priority traffic.
- b. Lightly used terminals too far from leased line terminals for an economical leased link.
- c. Need to communicate directly with other terminals for conversation or with terminals in other companies.

When a or b is the reason, the central equipment also needs access to the switched system, if the machine is capable. These access lines may only originate calls or may answer and originate. To take advantage of WATS flat rates, for example, the central usually does all originating. In this case, the number of access lines required at the central is based on connect time, (see 3 below) peak period message load, average message length, and line speed. Additional short messages must be added to the load to account for calls originated to stations so that they can send, but they have nothing to send ("Non-Productive Polls").

If the central must answer and originate calls, the number of access lines (trunks) is based on the same factors as above, except there are no dead polls, but the queueing problems demand less efficient lines at the central. For example, if 95% of the incoming calls are to be delayed less than 0.2 times the constant length message transmission time: one trunk can be 7% occupied, two trunks 24%, three trunks 35%, four trunks 42%, six trunks 52%, 12 trunks 68%, 20 trunks 78%, etc. These figures assume that a busy signal results in an immediate retry (which is not exactly true) and that delayed calls are answered in order (also not exactly true).

3. Control Times for Switched Lines

On TWX and the Telephone System, it takes about 25 seconds to "dial" and connect and disconnect, plus about 5 seconds to handshake and disconnect the data sets. Depending on the customer's requirements, identification time may have to be added to this before data starts moving. If "dialing" uses all touch tone equipment, about 15 seconds of "dialing" and connect time is saved.

On Telex, it takes about 24 seconds to "dial" by hand or machine and get connected and disconnected. Identification time is additional, if required.

Portions of the above control times may be chargeable time.

Manual Design - Summary

Most data communication networks should probably use some switched and some leased lines. The equipment capability and the application requirement are the determining factors. Each design must be evaluated and perhaps redesigned to get a good balance for the system operation.

LINE COST ANALYSIS

Communication Facilities are priced on a monthly basis. The areas of cost are:

1. To attach an IBM machine to a communication facility.
2. To have a facility access to service point.
3. To provide the facility between various service points.

Definitions

The following terms are used in the determination of the costs:

Service Point - A location (city/exchange) where one or more stations located.

Exchange/City - When leasing from phone companies, the term is exchange; when leasing from Western Union, the term is city. In all smaller cities, it may be assumed that, for pricing, the entire city is one exchange. Larger cities are broken up by both common carriers into exchange areas or zones. In general, it is not necessary to know what part of a zoned city the station is in unless a leased line segment serving the station is less than 40 miles long, or unless it is a switched system station.

Station - An equipment location. This can include all equipment in one building on the same line, but usually not in separate buildings. Extra equipment in the same building is connected as an extension. These rates are lower than local channels.

Local Channels or Loop - Required to connect each station to its channel terminal (except in Telpak).

Interstate/Intrastate - For leased line purposes, a line is interstate if any segment of it crosses a state line. An intrastate line has all of its segments wholly within one state. A system of lines connected to a single machine (but not interconnected to each other), can have some interstate lines and some intrastate lines.

Pricing A Network

When leased lines are used to connect several points on one line, a "minimum tree" of straight lines is designed to compute the line cost. Each segment of the tree is priced according to the rates, starting at zero miles for each segment. This minimum tree has no relation to the way the line is installed. Cumulative figures are shown in the rate tables for specific portions of each segment. To compute the cost of a segment, take the largest cumulative total mileage within the segment, then multiply the balance by the next per mile rate.

Another way to compute the cost of a leased facility between service points is to use equivalent miles. The actual straight line mileage is converted to equivalent miles using the percentages in the rate charts. Then the equivalent miles are multiplied by the rate for the first mile. This method is useful for multipoint, multi-line systems where each segment is converted to equivalent miles and all segments are totaled before multiplying by the rate for the first mile.

The example in Appendix B shows the various methods to arrive at the leased line cost. The results of the network design can be summarized as follows:

1. Leased line miles
2. Leased miles cost
3. Telpak cost
4. Number of lines
5. Number of stations
6. Number of loops
7. Cost of loops
8. Number of channel terminations
9. Cost of stations charges and channel terminations.
10. Total cost of communication facilities.

DESIGN EVALUATION

This step of network design should be done only when you have a network designed, priced and improved as much as possible. The objective of this exercise is to reduce cost by using other line arrangements.

Inspect the map for a number of multipoint lines that roughly parallel each other. If this situation exists, isolate the terminals involved and calculate the costs of the lines involved. This should be a simple matter of copying the costs from your previous network design worksheet. Occasionally there may be terminals in the selected arrangement that could be rerouted to increase this bundle. Some redesign of lines may be necessary. This redesign may affect lines already constructed. This should be expected during cost improvement

exercises. The bundle can then be implemented by using Telpak group rates or multiplexing techniques such as IBM 2712 or the shared line adapter.

Telpak channels may have excess capacity after the network is finished. No attempt should be made to reroute lines just to use this capacity. The prime objective is to reduce the line costs.

Occasionally a situation exists where either light traffic or little in the way of response time is necessary. Under these conditions long distance may be cheaper than routing a line to that terminal location. Obviously, there are many other system design criteria that must be evaluated before selecting the dial up system of toll calls instead of leased lines.

If traffic in a data-communicating system can be batched and scheduled, a design alternative would be Wide Area Telephone Service. The central processing unit would place a call to remote stations on a pre-scheduled basis.

Care must be taken when considering the application of a multiplexor or line sharing device. The importance of a well thought out "network analysis" cannot be over-emphasized. A line multiplexor and/or shared line device is not necessarily the answer to a multi circuit requirement. A careful cost study must be made for each and every communications system.

APPENDIX A1. TELEPHONE TECHNIQUES

BASIC PRINCIPLES

The telephone accomplishes the electrical transmission of speech by employing the mechanical energy of the speaker's voice to produce electric energy having similar characteristics, and in turn converting this electric energy into sound waves having similar characteristics at the listener's station.

The original telephone circuit, which was invented by Bell in 1876, consisted of a pair of transmitter-receiver instruments connected by wire. No battery was utilized.

Voice waves from the speaker at one of the instruments would strike a metal diaphragm in the telephone transmitter. The alternate condensations and rarefactions of the air on the speaker side of the diaphragm set it in vibration.

Behind the diaphragm was a permanent bar magnet. The magnet established part of its inductive field through the diaphragm. As the diaphragm vibrated, the lines of the magnetic field were alternately cut, and an AC voltage was established or induced in the wire which was wrapped about the bar magnet; this voltage had wave characteristics similar

to the characteristics of a sound wave. The AC voltage passed over the connecting wires to the receiver in the other telephone instrument. These voltage changes in the receiver magnet winding would alternately strengthen and weaken the magnetic field, thus increasing and decreasing its pull upon the receiver diaphragm. This causes the receiver diaphragm to "vibrate" in unison with the diaphragm at the transmitter end. The vibrating receiver diaphragm thus reproduced the original sound intelligently.

Telephone Receiver Construction

The earliest forms of telephone receivers were made with a permanent bar magnet as shown in Figure A1.1.

The efficiency of the receiver was later greatly increased by the use of a horseshoe magnet as shown in Figure A1.2. This permits the lines of magnetic force to pass in a much shorter path from one magnetic pole to the other through the iron diaphragm.

A later refinement was found in the bipolar receiver which provided built-in "acoustical" air chambers designed to have acoustical impedances which matched the electrical impedances and improved receiver efficiency. A more recent receiver design, which is currently standard for new installations is the ring-armature receiver. This unit utilizes a dome-shaped diaphragm driven like a piston by the magnetic field of the circular coil and pole piece.

Telephone Transmitter Construction

There are two types of transmitter units. The first of these units utilized a diaphragm vibrating in a magnetic field, thus generating an electrical current (such as the original Bell unit). In the early days of telephone this technique could be used only over short distances because of the comparatively weak currents, and a new unit was introduced, called the Blake transmitter. Here the diaphragm was used to vary the strength of an existing electrical current. The unit is shown in Figure A1.3. The transmitter diaphragm varies the pressure on the carbon granules which causes the resistance of the electrical circuit through the carbon granules to vary, thereby causing

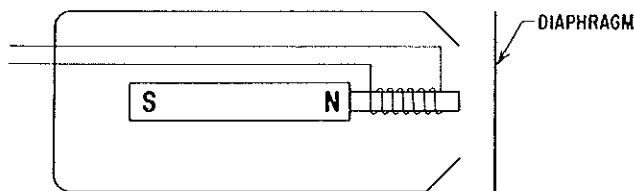

Figure A1.1 Bar magnet receiver

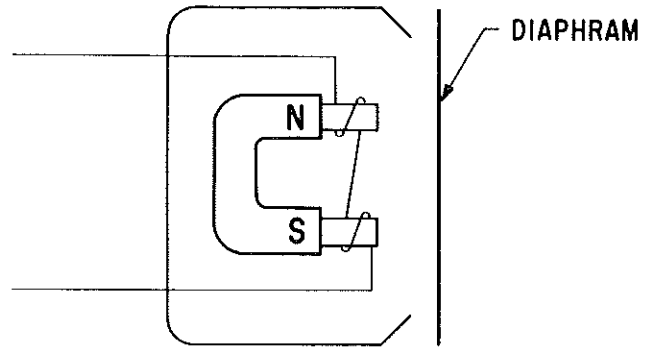

Figure A1.2 Horseshoe magnet receiver

a variation in the direct current in the circuit maintained by the battery. This establishes an alternating voltage in the secondary wiring of an induction coil, which sets up an alternating voltage in the line to the receiver. The second type of transmitter unit, commonly used in the subscriber's telephone set today, is the "direct action" type where the element attached to the diaphragm serves as the electrode and contact or pressure surface for the carbon chamber.

BASIC CIRCUITS

Figure A1.4 shows a telephone circuit with local battery transmitters. With the changing current through the primary of the induction coil, an alternating current is induced in the secondary of the coil. Current flows through the local receiver and is transmitted to the receiver at the distant station over the wire facility. In most telephone station installations, however, talking battery is supplied from a common battery located at the central office to which each subscriber line is connected.

An elementary subscriber circuit is shown in Figure A1.5. When the receiver is removed from its cradle, it closes the contacts of the "hook" switch and the subscriber line is activated at the exchange office. The battery is then connected in series with the primary winding of the induction coil

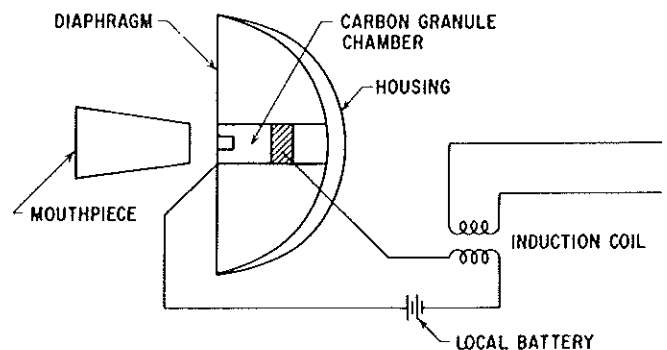

Figure A1.3 Basic telephone transmitter

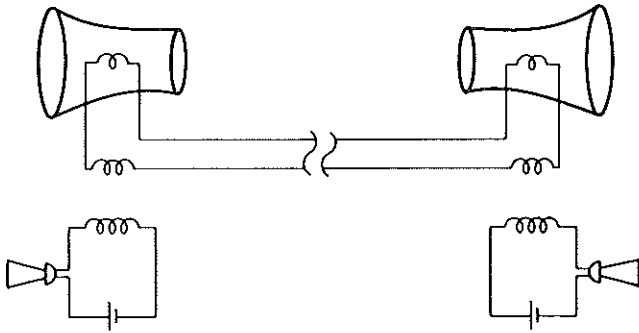

Figure A1.4 Basic telephone circuit with local battery transmission

and the transmitter. Talking into the transmitter will "modulate" the DC on the line. There is a receiver side tone path (ac) through the capacitor and coil secondary. When receiving, the ac variations divide between the receiver and transmitter circuits, and although losses occur, there is sufficient current to operate the receiver. On telephone sets containing dial equipment, the serial dc dial pulses are transmitted over the same pair by interrupting the battery. The dial mechanism consists of a cam-operated and governor-controlled interrupter switch.

APPENDIX A2. TELEGRAPH TECHNIQUES

BASIC PRINCIPLES

The elementary telegraph circuit consists of two telegraph terminals, each consisting of a relay, sounder, and key connected by a single wire. One set is connected to ground and the other to a grounded battery. Flow of current on the line occurs for the "operated" or marking position of the relay armature, and no current flows for the "open" or spacing position. The line current operates the receiving relay to the marking position, while an armature spring or a separately biased winding operates the relay to the spacing position.

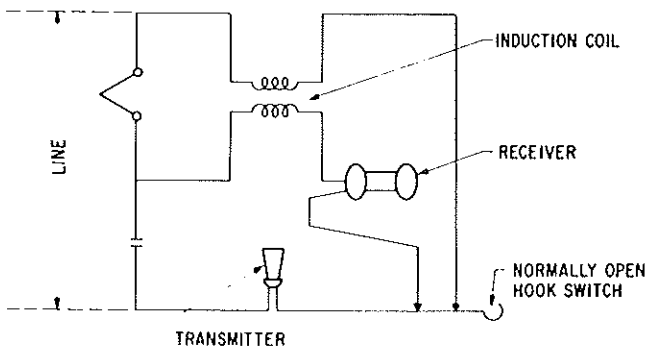

Figure A1.5 Basic common battery subscriber station

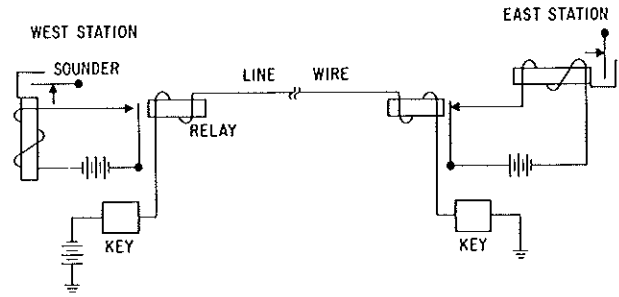

Figure A2.1 Elementary uni-polar telegraph circuit

Two types of telegraph systems are used for furnishing service to subscribers. These are known as neutral or unipolar signaling, and polar (commonly called bipolar) signaling. The neutral signaling is utilized 100% by AT & T and about 30% by Western Union. In this method, a single common battery voltage is used with the presence of current indicating the mark condition, and absence of current on the line indicating the space condition (See Figure A2.1).

In the bipolar technique, two oppositely connected common batteries are used; the mark is represented by positive voltage - current flow, and the space by the negative voltage source producing the opposite current flow (See Figure A2.2). The bipolar technique enables utilization of longer lines (up to 40 miles) as it is least affected by the line resistance and capacitive inductive change and decay effect. Seventy percent of the Western Union facilities use bipolar signaling.

Basic Device Operation

Teletypewriters are synchronized by means of a start/stop system. The fundamental idea of this system is that the machines, instead of operating continuously, will be stopped after the transmission of each series of five selecting pulses comprising the signal for one character (See Figure A2.3). This

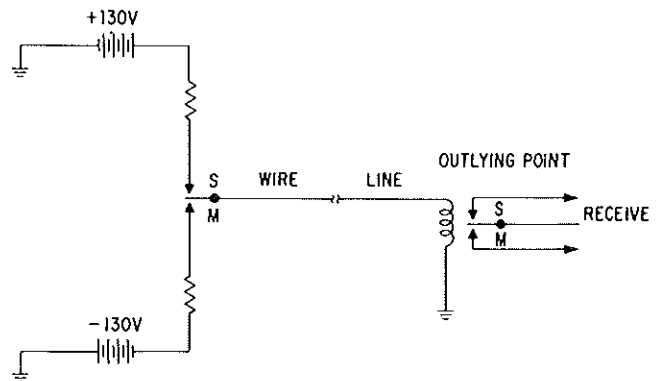

Figure A2.2 Bi-polar telegraph circuit (one way)

STANDARD TELEGRAPH FORMAT

SIGNAL LENGTHS IN MS - STAND. SPEEDS

60 SPEED/45 BAUD	22	22	22	22	22	22	31
75 SPEED/55 BAUD	18	18	18	18	18	18	25
100 SPEED/75 BAUD	135	135	135	135	135	135	19

CHARACTERS				CODE SIGNALS						
WEATHER	FRACTIONS	COMM	LETTERS	START	1	2	3	4	5	STOP
↑	-	-	A		●	●				●
⊕	5/8	?	B		●			●	●	●
○	1/8	:	C			●	●	●		●
/	\$	\$	D		●			●		●
3	3	3	E		●					●
→	1/4	1	F		●		●	●		●
↘	8	8	G			●		●	●	●
↓		#	H				●		●	●
8	8	8	I			●	●			●
/	1	1	J		●	●		●		●
←	1/2	(K		●	●	●	●		●
↖	3/4)	L			●			●	●
.	.	.	M				●	●	●	●
⊕	7/8	,	N				●	●		●
9	9	9	O					●	●	●
∅	0	0	P			●	●		●	●
1	1	1	Q		●	●	●		●	●
4	4	4	R			●		●		●
BELL	BELL	BELL	S		●		●			●
5	5	5	T						●	●
7	7	7	U		●	●	●			●
⊕	3/8	;	V			●	●	●	●	●
2	2	2	W		●	●			●	●
/	/	/	X		●		●	●	●	●
6	6	6	Y		●		●		●	●
+	"	"	Z		●				●	●
-	BLANK	}}								●
LETTERS		↓	SYMBOLS TO LEFT ON TAPE ONLY		●	●	●	●	●	●
FIGURES		↑			●	●		●	●	●
SPACE		■					●			●
CARRIAGE RETURN		<						●		●
LINE FEED		=				●				●

Figure A2.3 Standard telegraph format

ensures that the two machines will be in exact synchronism at the beginning of transmission of each character.

An elementary diagram of the mechanics of a start-stop teletypewriter system is shown in Figure A2.4.

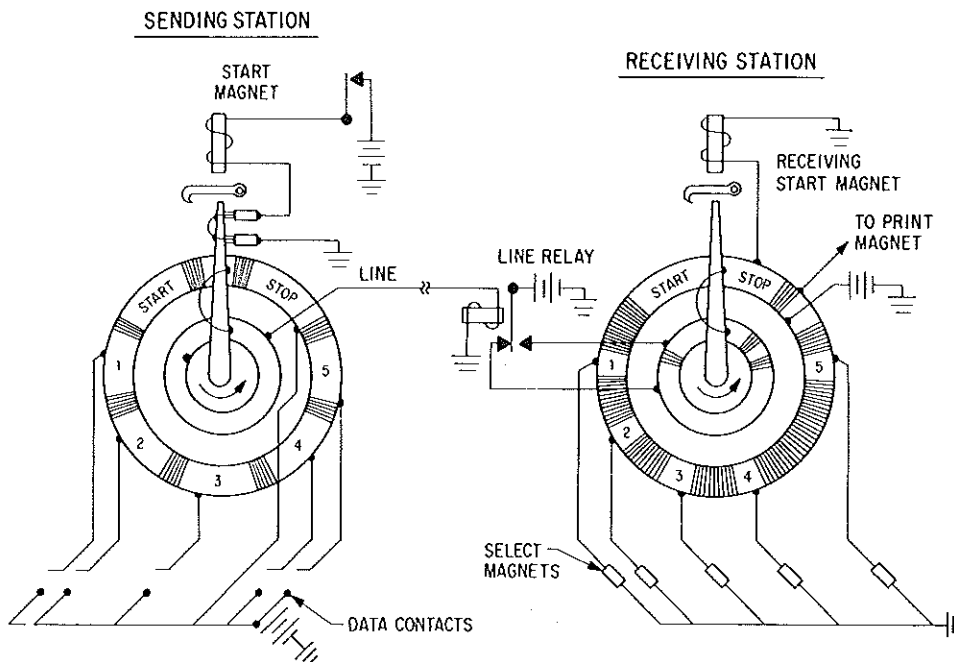

Figure A2.4 Theory of start-stop teletypewriter system

The sending and receiving telegraph machines contain a pair of devices known as distributors. The start pulse at the sending terminal releases the receive line relay, and connects the battery to the receive start magnet. This permits the receiving distributor arm to start to rotate. As the distributor arms rotate, the transmitting distributor arm makes contact with each transmit data segment sequentially. These segments, which are connected to battery, transmit the battery condition over the line to the corresponding segment of the receiving distributor and the associated select magnet will be operated. When the stop signal is transmitted, it will hold the receiving line relay closed, preventing battery from reaching the receive start magnet, and the receiving distributor arm will be halted by its latch as it completes one character. Both distributors are then in position to handle the next character. The elongated stop bit (1.42 times as long as the data bit) is used to ensure mechanical synchronization between the two machines before the subsequent character is transmitted.

TELEGRAPH REPEATERS

As in all other electrical communications systems, telegraph signals are subjected to attenuation or loss of energy when transmitted over any considerable distance.

The elementary telegraph circuit is limited to comparatively short distances because the current would not be sufficient to operate the receiving relays. Also, signal distortion caused by long lines

would introduce errors. This problem is solved by the use of line repeaters of the following types:

1. Single line - a pair of cross-coupled polar relays are inserted in series with the circuit and these reprove the signal to the adjacent links.
2. Regenerative Repeaters - Since ordinary telegraph line repeaters will repeat the greater part of distortion which increases cumulatively with the distance of the over-all circuit, regenerative repeaters are used. The function of this repeater is to retine and retransmit (power) received signal impulses. It is capable of receiving, without error, any set of signals that would be satisfactorily received by an ordinary teletypewriter, and can send these same signals out in exactly the same form as is produced by the sending teletypewriter.

Three types of this repeater are normally utilized:

- a. Rotating Brush
- b. CAM type
(both a and b are electro-mechanical)
- c. Electronic

Regenerative repeaters (commonly called Regen's) are speed and code-sensitive and are intended for use with standard telegraph codes. This can be a problem when using other low speed terminal devices (such as the IBM Transceiver) and telegraph channels.

Although regenerative repeaters are not generally utilized except in very long point-to-point connections, they are almost always found in multi-point teletype nets where the multiplicity of connections and drops increase noise and distortion pickup to

unsuitable levels. (In laying out a telegraph system, the common carrier will "grade" each interconnection link of the system by assigning it a circuit coefficient. When the summed coefficient reaches 10, a regenerative repeater is inserted. The figure 10 corresponds to an error rate of approximately 1 character error in 44 thousand).

TELEGRAPH DISTORTION

Bias Distortion

There is a definite interval between the time the telegraph circuit is closed and the time the relay operates. The interval is called the "space-to-mark transition delay" (S-MTD).

It is important that the space-to-mark transition delay equal the mark-to-space transition delay. If the two delays are not equal, as for instance, if the M-STD is greater than the S-MTD, all marks will be lengthened and all spaces shortened. This is a common condition on circuits and is called "marking bias". The opposite situation, in which the spaces are lengthened and marks shortened, is called "spacing bias". If, for example, the M-STD of a circuit is 6 ms and the S-MTD is 3 ms, the bias is "plus three"; this indicates that every mark, regardless of length, will be increased 3 ms and each space will be decreased 3 ms. Bias distortion can be reduced by adjusting the bias current on the affected telegraph sets.

Characteristic Distortion

Transitions are assumed to start when the line current is in the steady state marking or spacing condition. In some cases, however, the start of the transition does not occur when the line current is at its steady state value and this situation is called "changing current transition". This affects the lengths of the received signal impulses and is called characteristic distortion. When the receive pulses are shortened, the effect is called negative characteristic distortion. When the pulses are lengthened, it is called positive characteristic distortion.

Fortuitous Distortion

This random or intermittent form of distortion is caused by such items as cross fire, power inductions, battery fluctuations, hits, and break key operation. The combined effect of characteristic and fortuitous distortion is sometimes known as jitter.

APPENDIX A3. COAXIAL CABLE & MICROWAVE

COAXIAL CABLE

A coaxial pair consists of two wire or conductors. Unlike conventional pairs, one wire is a cylindrical tube in which a second solid conductor or core is centered. As shown by Figure A3.1 the center core is held accurately in place by an insulating material. This insulating material may take the form of a solid core, discs, or beads strung along the axis of the wire, or by a spirally wrapped insulator.

The center conductor must be accurately placed and held because at radio frequencies, the electrical characteristics of a coaxial pair are dependent upon physical dimensions. Several coaxial pairs grouped together inside an outer protective cover or sheath make up a coaxial cable. Typical coaxial cables contain from 2 to as many as 20 coaxial pairs plus a center group of conventional pairs. See Figure A3.2.

A coaxial transmission line transmits a high frequency signal as an electromagnetic wave in the area between the center conductor and shield. The energy of the signal is actually in the space. The outer conductor is called a shield because it blocks interfering signals from adjacent circuits. It also contains the signal energy within the coax. This is especially important because, as was stated previously high frequency, energy tends to radiate in all directions and dissipate.

As frequencies were increased into the super-high frequency range, greater information handling capabilities were obtained. However, with operation in these higher frequencies, the losses in coaxial conductors also increased. As a result,

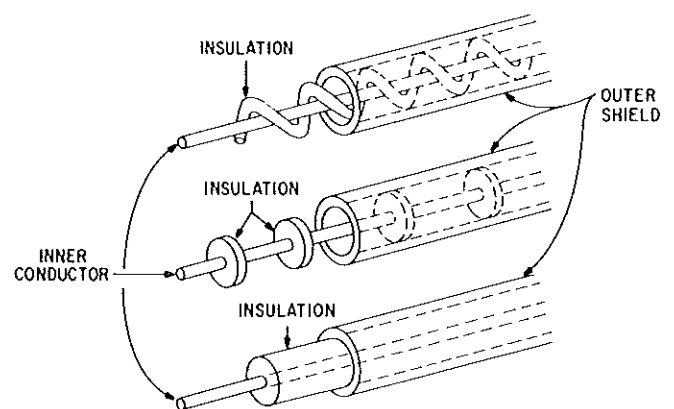

Figure A3.1 Coaxial tube construction

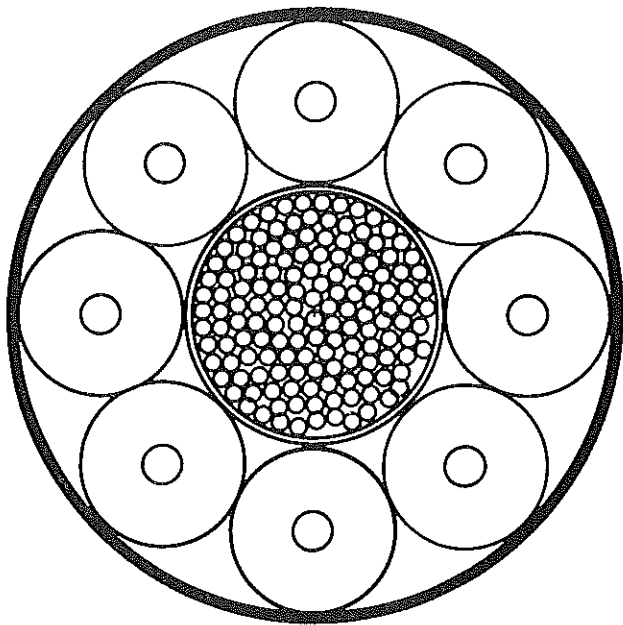

Figure A3.2 Coaxial cable cross-section

new facilities such as microwave were developed and the coaxial pair use at super high frequencies was limited primarily to short sections feeding the new facilities described in the next two sections.

MICROWAVE SYSTEMS

Microwave means a very short wave with a length measured in centimeters. Signals having this wavelength are in the 1,000 to 10,000 megacycle range. Microwave systems actually are radio systems operating in this super-high frequency range or at the top of the workable frequency spectrum which is shown in Figure A3.3. Because of their short wave length, microwaves exhibit some of the characteristics of light waves. They travel in straight lines, can be reflected, and through the use of special lenses, can be directed or focused. Microwave systems also are called radio-relay systems.

High capacity microwave terminals have two antennas – one for transmitting only and one for receiving only. Most privately owned systems are lightly loaded and can use one antenna for both transmit and receive. The transmitting and receiving channels are usually separated by about 40 megacycles to avoid interference. Microwave signals also are subject to losses and must be periodically boosted and amplified. Losses are caused by

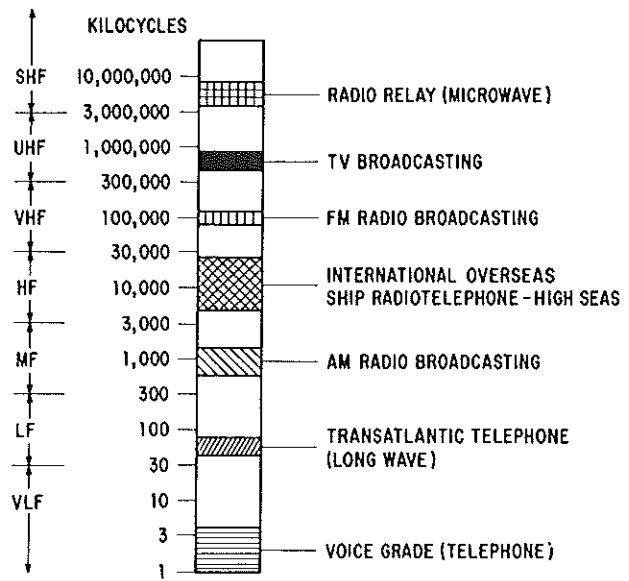

Figure A3.3 Frequency spectrum

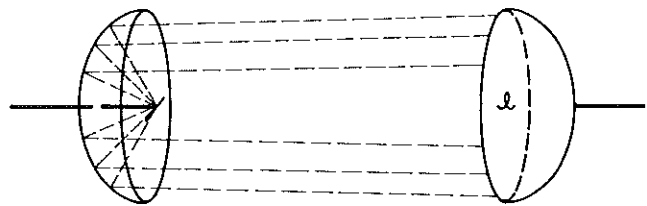

Figure A3.4 Parabolic reflector antenna

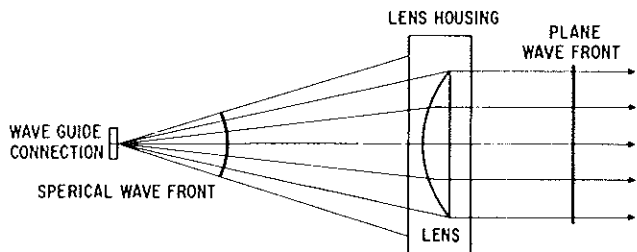

Figure A3.5 Delay lens horn antenna

the atmosphere and the fact that microwave energy cannot be perfectly focused, meaning only a portion of the transmitted signal is received. Amplifying points are called relay stations and are located 25 to 35 miles apart. This spacing sometimes varies because of mountains or other obstructions. Relay stations usually have four antennas and are located between end terminals.

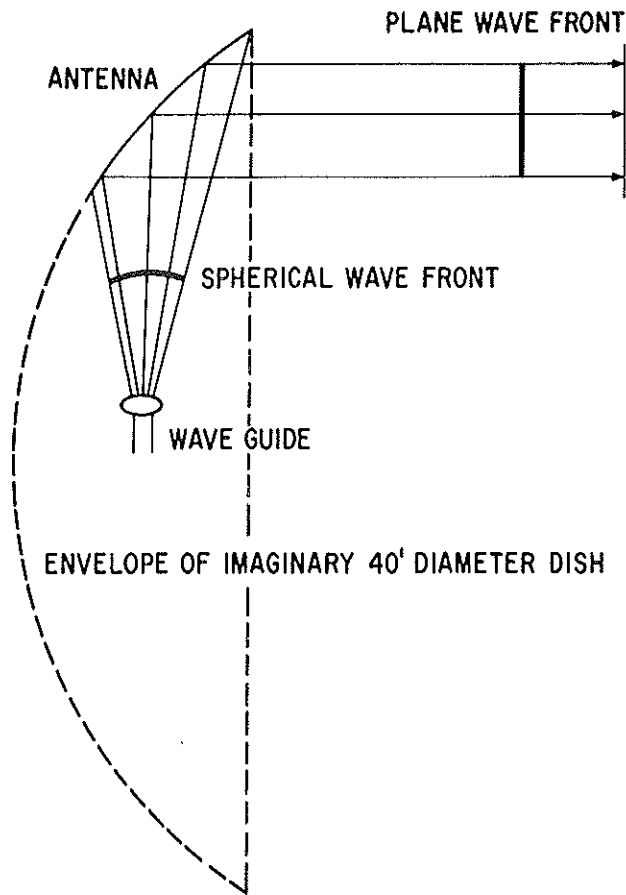

Figure A3.6 Horn-reflector antenna

APPENDIX A4. DATA SET OPERATION

The first data set was introduced in the late 1950's and was basically a carrier telegraph terminal moved from the central office to the customer's premises. Most data sets are located on the customer's premises in close proximity to their

associated business machine. Figure A4.1 shows a typical data set configuration. Most digital data sets are capable of two-way operation - either on a half or full duplex basis. This type data set which must be able to both MODulate and DEModulate is called a MODEM. Data sets may use different modulating schemes and also have different speeds of operation. The maximum transmission rate now available with DATA PHONE Data Service is 2,000 bits per second. Many data sets are capable of unattended operation which means, when called, they can turn themselves and their associated business machine on without human intervention and send back control signals to the calling station. These can be wired permanently for unattended operation (under control of a business machine) or they can be made unattended under control of a push button.

To illustrate the operation the Bell System 100 series data set has two separate carrier frequencies - 1170 and 2125 cycles per second and can transmit using either carrier. However, when a station originates a call, it always transmits with the low frequency carrier. The same station, if called, would always transmit using the high frequency carrier. Selection of the carrier frequency used, is dependent upon whether the station originates or receives the call. The data set uses frequency shift keying (FSK) modulation. With this arrangement, a mark ("one bit") will shift the carrier upward 100 cycles from 1170 to 1270 cycles or from 2125 to 2225 cycles. A space ("zero bit") will shift the carrier downward 100 cycles from 1170 to 1070 cycles or from 2125 to 2025 cycles. Figure A4.2 shows the 100 series data set operation in a typical call sequence. The exchange of f2m and f1m frequencies is referred to as "handshaking".

Our concern is not to understand the numerous sets in each series, but rather, to understand in general the principle of their operation and to know which type will work with specific terminals. As

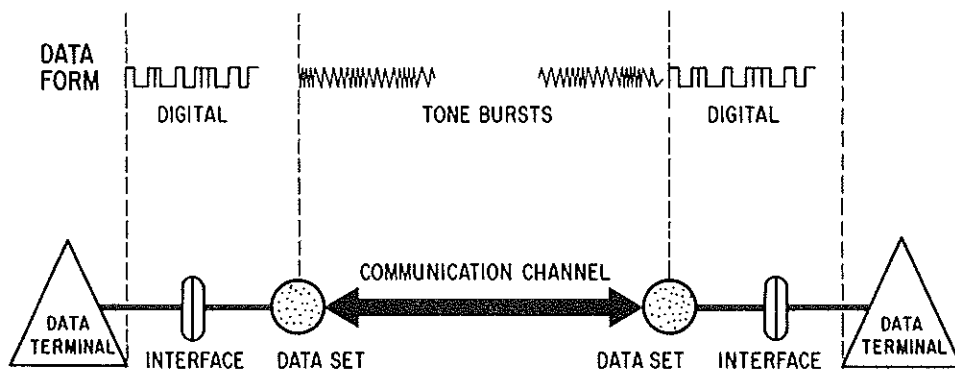

Figure A4.1 Data set operation

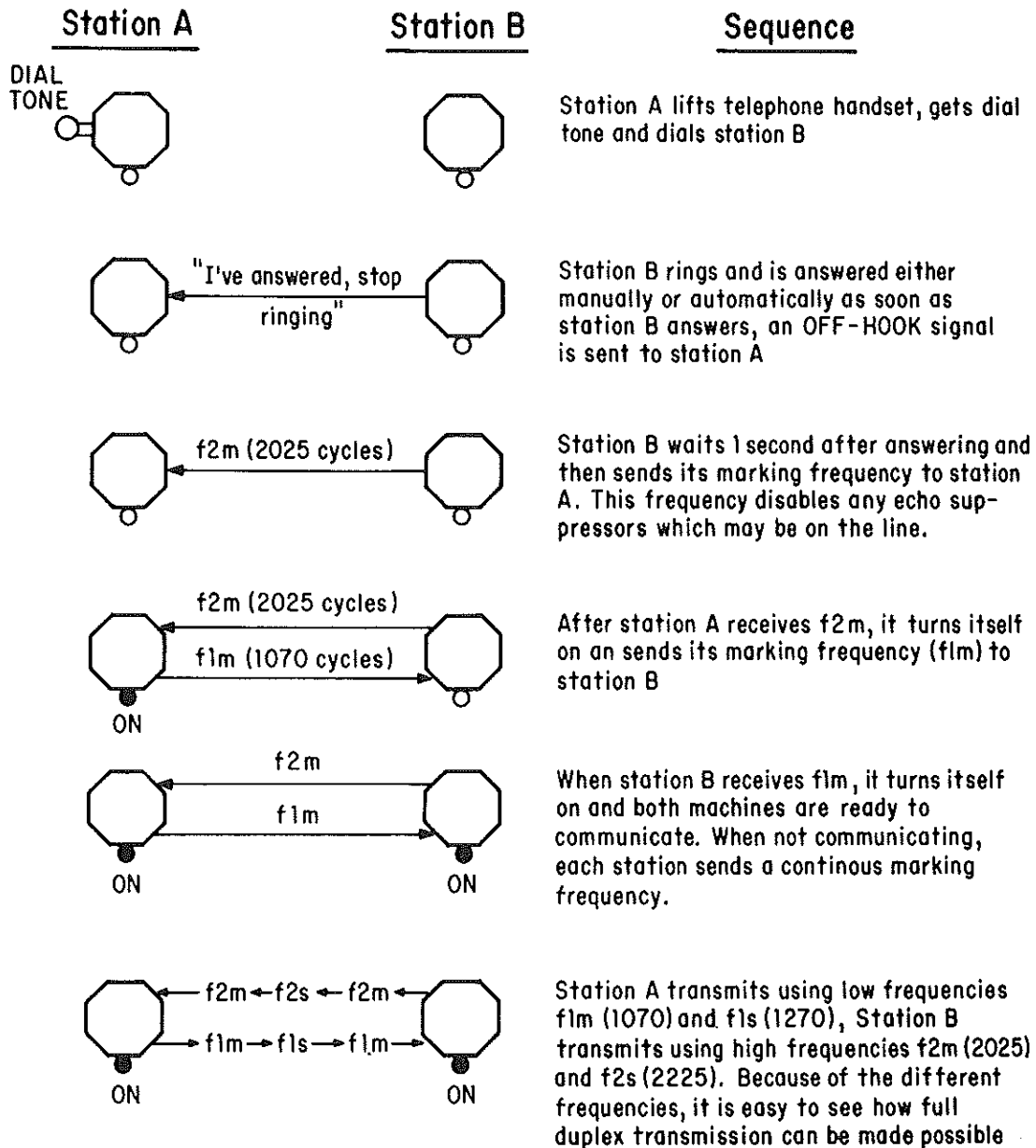

Figure A4.2 Data set handshaking

seen by Figure A4.3, the junction between a common carrier data set and a data terminal is called an interface. This junction is a boundary or threshold over which information is passed from business machine to data set for transmission; or from data set to business machine for reception of data.

Most interfaces are designed in accordance with EIA (Electronic Industries Association) Standard #RS-232B. This standard completely defines the functions and operation of the many different leads or circuits, describes their electrical limitations, and specifies the physical interface connector with the number of pins to be used.

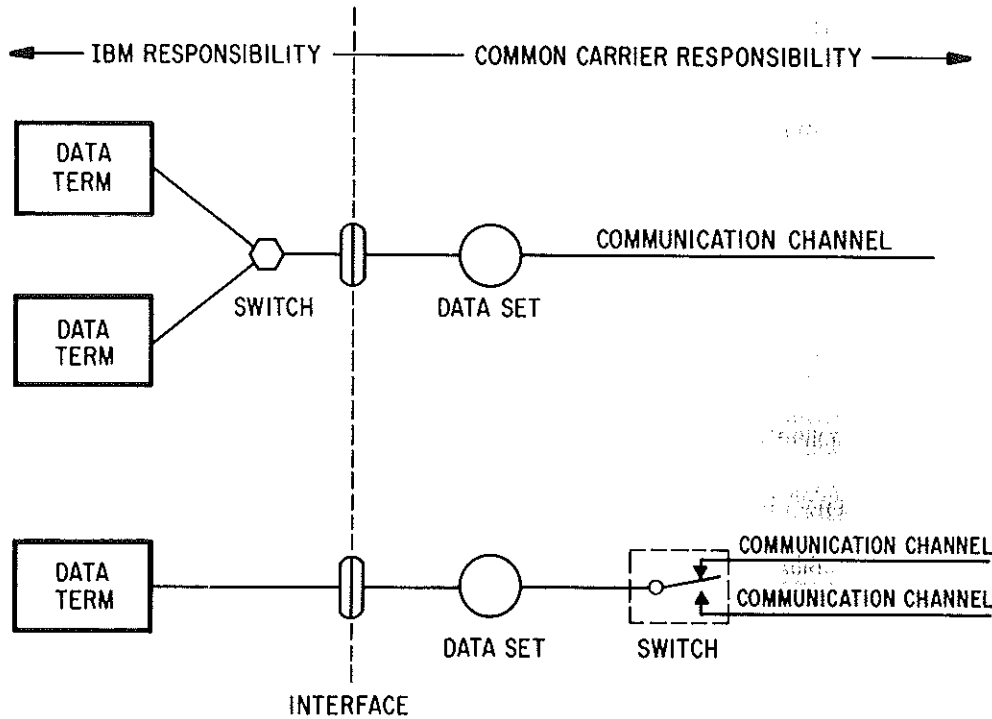

Figure A4.3 Alternate connecting arrangements

APPENDIX B. Example of Manual Network Design

As an example of the method described in this guide for Manual Design of a Leased System, a small system connecting 11 cities to Jonesboro, Arkansas is designed. The fixed information obtained about the problem is listed below:

1. Cities and total message loads/peak hour (avg. 200 ch/msg input and output):

Auburn, Washington	33.0
Long Beach, California	9.2
Glendale, California	67.5
Napa, California	9.2
Santa Rosa, California	31.7
Watsonville, California	35.3
Jackson, Wyoming	11.1
Magnolia, Arkansas (1)	29.5
Magnolia, Arkansas (2)	61.3
Galveston, Texas	45.6
Humble, Texas	37.6
Monroe, Louisiana	18.5

2. The network we wish to design is a full time, half duplex, 100 wpm, leased telegraph line network with the following network parameters:

a. A ratio of input messages to output messages of 1:1.1

- b. Control of 8 character times
- c. Full control polling (one message per poll) of each station.
- d. 90% of messages must be delivered in less than 7.5 minutes.
- e. Terminals operate 10 cps line speed.

3. From the parameters given, we find that the control time (or poll time or address time) is 8 character times. Thus LCT is 8 characters. Since the line speed is 10 cps, LCT could also be expressed as .8 seconds. LHT is the average message length + control time = 200 characters + 8 characters = 208 characters or 20.8 seconds. The ratio of LCT:LHT would be 8/208 or 1:26. The R_{IO} is 1:1.1, which means we will be working with graphs #1 and #2. Because the LCT:LHT = 1:26, we will use the lower curve on graph #1.

In the parameters we have been given the percentile of messages $P = 90\%$ and the response time $T = 7.5$ minutes or 450 seconds (7.5×60). We are thus looking for the line utilization U . Entering graph #2 at 90%, we find a Y_u of 2.1. Since $Y_p = \frac{T}{MRT}$ (from D.2.),

$$MRT = \frac{450 \text{ seconds}}{2.1} = 214 \text{ seconds.}$$

$$Y_u = \frac{MRT}{LHT} + \frac{214}{20.8} \text{ seconds} = 10.3.$$

Entering graph #1 with a Y_u of 10.3 and using the lower curve, we find that $U = 80.5\%$ utilization. Thus the maximum line utilization for our system requirements is 80.5%. One 100 wpm telegraph line is capable of transmitting 10 characters per second, 600 characters per minute or 3600 characters per hour. Since each message has an average of 208 characters (we must include control time), the line is capable of handling $\frac{3600 \text{ char/hr}}{208 \text{ char/mes}} = 172$ messages/hour maximum. To load the line to 80.5% utilization, we allow only $172 \times .805 = 138$ messages/hour on the line. The 138 messages/hour is thus our line loading factor. Notice that this is total messages/

hour. The traffic rate from each city is also expressed at total number of messages (both in and out)/hour. If the city traffic rate is expressed in other units, then the line loading factor must be in the same units.

4. By following the procedure outlined previously, we manually construct a network. We see that Watsonville, Napa and Santa Rosa will all be connected on the same line. Since the distance from Santa Rosa to Auburn is less than Watsonville to Glendale, we make the Santa Rosa - Auburn connection. From Auburn we go to Jackson and then the DPC. This line now has 120.3 messages/hour which is nearly equal to the line loading factor. By similar analysis the rest of the network was configured and the cost was then computed. The resultant network is shown below.

	From	To	Load	Distance in Miles	Equivalent Miles
Line 1	Galveston	Humble	45.6	49.5	49.5
	Humble	Magnolia (1)	37.6	247	247
	Monroe	Magnolia (1)	18.5	82.5	82.5
	Magnolia (1)	Jonesboro	29.5	225	225
		Total	131.2		
	From	To	Load	Distance in Miles	Equivalent Miles
Line 2	Long Beach	Glendale	9.2	30	30
	Glendale	Magnolia (2)	67.5	1420	722
	Magnolia (2)	Jonesboro	61.3	225	225
		Total	138.0		
	From	To	Load	Distance in Miles	Equivalent Miles
Line 3	Watsonville	Napa	35.3	82.5	82.5
	Napa	Santa Rosa	9.2	22.5	22.5
	Santa Rosa	Auburn	31.7	600	415
	Auburn	Jackson	33.0	610	419
	Jackson	Jonesboro	11.1	990	571
		Total	120.3		3091

The total line cost for the system would be 3091×1.21 (from AT&T Schedule 3 cost for 100 wpm telegraph) = \$3,740. The local channel costs are

$15 \times \$6.70$ or \$100. The channel terminal charges are $15 \times \$12.50$ or \$187.50. Thus the total cost of the network is \$4,027.50. A map of this solution is shown below.

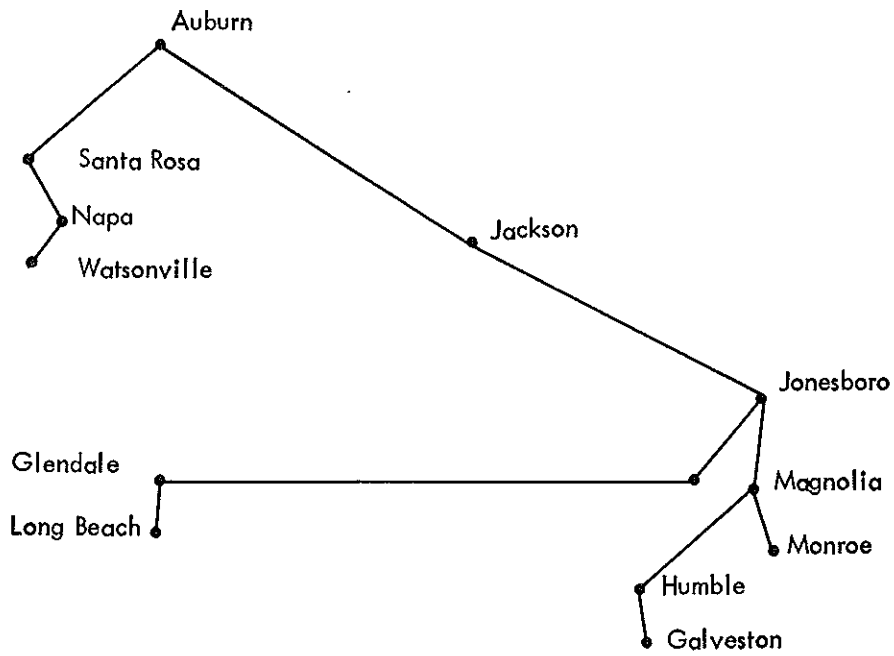

NETWORK CONFIGURATION

TELE-COMMUNICATIONS BIBLIOGRAPHY

GENERAL PUBLICATIONS

1. Principles of Electricity Applied to Telephone and Telegraph Work. A training course text prepared for employees of the Long Lines Department, American Telephone and Telegraph Co. 1953. \$4.20. Available locally through Graybar Electrical Co., Inc.
2. Information Transmission, Modulation and Noise. Mischa Schwartz. McGraw-Hill. New York. A Mathematical Treatment. Highly Technical.
3. An Introduction to Information Theory. Fazlollah M. Reza. McGraw-Hill. New York. 1961. A Mathematical Treatment. Highly Technical.
4. Information Theory. Gordon Raisbeck. The M.I.T. Press. Cambridge, Mass. 1964. \$4.00. Concise but informative.
5. Telephone Traffic Engineering Handbook.

No longer available
6. Design of Communications Systems. Keats A. Pullen, Jr. Hayden Book Co., Inc. New York. 1963. \$2.75.
7. Transmission Systems for Communications. Available through Graybar Electrical Co., Inc. locally.
8. Symbols, Signals and Noise. J.R. Pierce. Harper Brothers. New York. 1961.
9. Principles of Coding, Filtering and Information Theory. Leonard S. Schwartz. New York University Press. New York. \$8.50
10. A Methodology for Systems Engineering. Arthur D. Hall. D. Van Nostrand Co., Inc. Princeton, N.J. 1962.
11. System Engineering. Goode and Machol. McGraw-Hill, New York. 1957.
12. Real Time Data Processing Systems: Introductory Concepts. William H. Desmonde. Prentice Hall, Inc. Englewood Cliffs, N.J. 1964.
13. Modern Communications. Crowley, Harris, Miller, Pierce and Runyon. Columbia University Press. 1962. \$9.75.
14. Real Time Business Systems. Robert V. Head, Holt, Rinehart and Winston, Inc. \$9.00.
15. The Story of Communications from Beacon Light to Telstar. Senator John O. Pastore. MacFadden-Bartall Corp. \$.95.
16. Microanalysis of Socio-economic Systems: A Simulation Study. Orcutt, Greenberger, Korbel and Riulin. Harper & Brothers, New York. 1961. \$8.00.
17. Basic Carrier Telephony. David Talley. John F. Rider, Inc. New York. 1960. Simple presentation of complex subject.
18. Data Transmission. Western Union. 1961.
19. EIA Standard RS - 232 - A. October 1963. Interface specification standard. Available from: EIA, 11 West 42nd Street, New York, New York. \$.90.
20. Bell System Data Communications Technical Reference Manuals.

These booklets are published by AT & T and available retail through your local Graybar Electric Company Sales Office, or from Graybar Electrical Company, Inc. Except for the binder, prices vary from 30 cents to \$1.50. The available items are:

Bell System Data Communication Services
Data Set Interface Connectors
Data Set 103A Interface Specification
Data Set 103B Interface Specification
Data Set 103F Interface Specification
Data Set 201 A/B Interface Specification
Data Set 202 A/B Interface Specification

Data Set 202 C/D Interface Specification
 Data Set 301B Interface Specification
 Data Set 401 A/B Interface Specification
 Data Set 401 E/F Interface Specification
 Data Set 401J Interface Specification
 Data Set 402 A/B Interface Specification
 Data Set 602A Interface Specification
 Data Auxiliary Set 801A (Auto Call)
 Interface Specification
 Matching Looseleaf Binder

The manuals on data sets contain very good operating descriptions as well as detailed information about wires and electrical specifications.

21. Psychological Principles in System Development. Edited by Robert M. Gagne. Holt, Rinehart and Winston, New York. 1962.
22. What is Cybernetics? G. T. Guilband. Criterion Book, New York. 1959. \$3.50.
23. Fundamentals of Telephony. Arthur L. Albert. McGraw-Hill, New York. 1913. \$7.00.
24. On Human Communication. Colin Cherry. John Wiley & Sons, Inc., New York. 1961.
25. Telecommunications Services for Government and Industry. Western Union. 1962.
26. Programming Real Time Systems. James Martin. Prentice Hall, Inc. Englewood Cliffs, N.J. 1964. \$11.75.
27. Systems Engineering Tools. Harold Weiss. John Wiley and Sons, Inc. New York, N.Y. 1965. 646 pp. \$12.95
28. Data Transmission and Data Processing Dictionary. James F. Holmes. John F. Rider Publisher, Inc., New York, N.Y. 1965. 103 pp. \$2.50.
29. Data Communications in Business. Edgar C. Gentle, Jr., Editor. American Telephone and Telegraph Company. New York. 1965. 163 pp. \$2.00.

IBM PUBLICATIONS

1. IBM Tele-Processing Bibliography. A24-3089. Lists Hardware & Physical Planning Manuals mostly.

2. IBM Tele-Processing Systems Summary. A24-3090. Brief description of T.P. Equipment.
3. Data Communications. Charles R. Doty, Sr., IBM Fellow. Review of IBM roll in communications available from Development Laboratory, IBM-Poughkeepsie.
4. IBM Tele-Processing Components Physical Planning. A24-3233.

GOVERNMENT PUBLICATIONS

Available from Superintendent of Documents
 U.S. Government Printing Office
 Washington 25, D.C.

1. Communications. Volume XII. Science Technology, and Development. United States Papers prepared for the United Nations Conference on the Application of Science and Technology for the Benefit of the Less Developed Areas. Price - \$.50.
2. Statistics of the Communication Common Carriers, Year Ending 1963. Price - \$.60.
3. Communications Act of 1934 with Amendments Indexed Thereto. Price - \$1.30.
4. Federal Communications Commission's List of Printed Publications. Administrative Bulletin No. 1. January 1964. Available free for the asking. Address Federal Communications Commission, Washington, D.C. 20554.

PERIODICALS

1. Western Union Technical Review. Western Union, 60 Hudson Street, New York, New York. Quarterly.
2. The Lenkurt Demodulator. Lenkurt Electric Co., Inc., San Carlos, California. Monthly. Free on request.
3. Telecommunication Report. Telecommunication Report 1210 National Press Bldg., Washington, D.C. Weekly.

4. Computer Design. Computer Design Publishing Corp. Professional Bldg. Baker Avenue, West Concord, Massachusetts. Monthly.
5. Signal Magazine. Journal of the Armed Forces Communications and Electronics Assn. 1725 Eye Street, Washington, D.C. Monthly.
6. Telephony Magazine. Telephony Publishing Corp., 608 South Dearborn, Chicago, Illinois 60605.
7. I.E.E.E. Spectrum. I.E.E.E., 345 E. 47th Street, New York, New York 10017.
8. Industrial Communication. R.E. Tall, Editor. 1327 F Street, N.W., Washington, D.C.
9. Bell Laboratories Record. Bell Telephone Laboratories, Inc., 463 West Street, New York, New York. \$2.00 per year.
10. Bell System Technical Journal. Bell Telephone Laboratories, Inc., 463 West Street, New York, New York.
11. IBM Journal of Research and Development. IBM Corp., Armonk, New York. Quarterly. \$5.00 per year.
12. Telephone Engineer and Management. Harbrace Publications, Inc., 402 West Liberty Drive, Wheaton, Illinois 60187.



International Business Machines Corporation
Data Processing Division
112 East Post Road, White Plains, N. Y. 10601
(USA Only)

IBM World Trade Corporation
821 United Nations Plaza, New York, New York 10017
(International)

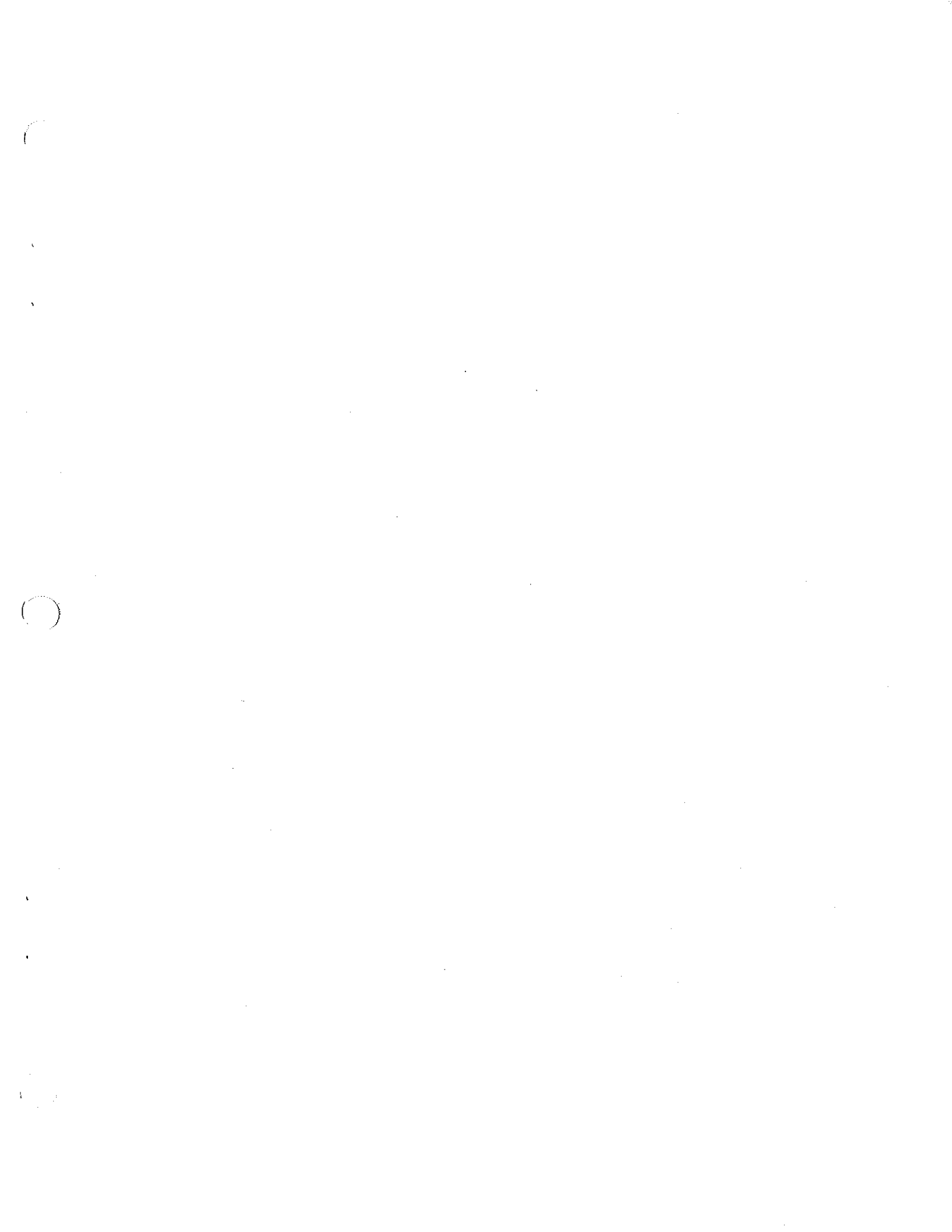



International Business Machines Corporation
Data Processing Division
112 East Post Road, White Plains, New York 10601
(USA only)

IBM World Trade Corporation
821 United Nations Plaza, New York, N.Y. 10017
(International)

GC20-1668-1

Data Communications Primer Printed in U.S.A. GC20-1668-1